

# TLE207x, TLE207xA EXCALIBUR LOW-NOISE HIGH-SPEED JFET-INPUT OPERATIONAL AMPLIFIERS

SLOS181B – FEBRUARY 1997 – REVISED APRIL 2004

- Direct Upgrades to TL05x, TL07x, and TL08x BiFET Operational Amplifiers
- Greater Than 2× Bandwidth (10 MHz) and 3× Slew Rate (45 V/μs) Than TL07x
- Ensured Maximum Noise Floor 17 nV/√Hz
- On-Chip Offset Voltage Trimming for Improved DC Performance
- Wider Supply Rails Increase Dynamic Signal Range to ±19 V

## description

The TLE207x series of JFET-input operational amplifiers more than double the bandwidth and triple the slew rate of the TL07x and TL08x families of BiFET operational amplifiers. Texas Instruments Excalibur process yields a typical noise floor of 11.6 nV/√Hz, 17-nV/√Hz ensured maximum, offering immediate improvement in noise-sensitive circuits designed using the TL07x. The TLE207x also has wider supply voltage rails, increasing the dynamic signal range for BiFET circuits to ±19 V. On-chip zener trimming of offset voltage yields precision grades for greater accuracy in dc-coupled applications. The TLE207x are pin-compatible with lower performance BiFET operational amplifiers for ease in improving performance in existing designs.

BiFET operational amplifiers offer the inherently higher input impedance of the JFET-input transistors, without sacrificing the output drive associated with bipolar amplifiers. This makes them better suited for interfacing with high-impedance sensors or very low-level ac signals. They also feature inherently better ac response than bipolar or CMOS devices having comparable power consumption.

The TLE207x family of BiFET amplifiers are Texas Instruments highest performance BiFETs, with tighter input offset voltage and ensured maximum noise specifications. Designers requiring less stringent specifications but seeking the improved ac characteristics of the TLE207x should consider the TLE208x operational amplifier family.

Because BiFET operational amplifiers are designed for use with dual power supplies, care must be taken to observe common-mode input voltage limits and output swing when operating from a single supply. DC biasing of the input signal is required and loads should be terminated to a virtual ground node at mid-supply. Texas Instruments TLE2426 integrated virtual ground generator is useful when operating BiFET amplifiers from single supplies.

The TLE207x are fully specified at ±15 V and ±5 V. For operation in low-voltage and/or single-supply systems, Texas Instruments LinCMOS families of operational amplifiers (TLC- and TLV-prefix) are recommended. When moving from BiFET to CMOS amplifiers, particular attention should be paid to slew rate and bandwidth requirements and output loading.



Please be aware that an important notice concerning availability, standard warranty, and use in critical applications of Texas Instruments semiconductor products and disclaimers thereto appears at the end of this data sheet.

PRODUCTION DATA information is current as of publication date. Products conform to specifications per the terms of Texas Instruments standard warranty. Production processing does not necessarily include testing of all parameters.



POST OFFICE BOX 655303 • DALLAS, TEXAS 75265

Copyright © 1997 – 2004, Texas Instruments Incorporated

# TLE207x, TLE207xA EXCALIBUR LOW-NOISE HIGH-SPEED JFET-INPUT OPERATIONAL AMPLIFIERS

SLOS181B – FEBRUARY 1997 – REVISED APRIL 2004

## TLE2071 AVAILABLE OPTIONS

T <sub>A</sub>	V <sub>I0</sub> max AT 25°C	PACKAGED DEVICES				
		SMALL OUTLINE† (D)	CHIP CARRIER (FK)	CERAMIC DIP (JG)	PLASTIC DIP (P)	CERAMIC FLAT PACK (U)
0°C to 70°C	2 mV 4 mV	TLE2071ACD TLE2071CD	—	—	TLE2071ACP TLE2071CP	—
–40°C to 85°C	2 mV 4 mV	TLE2071AID TLE2071ID	—	—	TLE2071AIP TLE2071IP	—
–55°C to 125°C	2 mV 4 mV	— —	TLE2071AMFK TLE2071MFK	TLE2071AMJG TLE2071MJG	— —	TLE2071AMU TLE2071MU

† The D packages are available taped and reeled. Add R suffix to device type (e.g., TLE2071ACDR).

## TLE2072 AVAILABLE OPTIONS

T <sub>A</sub>	V <sub>I0</sub> max AT 25°C	PACKAGED DEVICES				
		SMALL OUTLINE† (D)	CHIP CARRIER (FK)	CERAMIC DIP (JG)	PLASTIC DIP (P)	CERAMIC FLAT PACK (U)
0°C to 70°C	3.5 mV 6 mV	TLE2072ACD TLE2072CD	—	—	TLE2072ACP TLE2072CP	—
–40°C to 85°C	3.5 mV 6 mV	TLE2072AID TLE2072ID	—	—	TLE2072AIP TLE2072IP	—
–55°C to 125°C	3.5 mV 6 mV	—	TLE2072AMFK TLE2072MFK	TLE2072AMJG TLE2072MJG	—	TLE2072AMU TLE2072MU

† The D packages are available taped and reeled. Add R suffix to device type (e.g., TLE2072ACDR).

## TLE2074 AVAILABLE OPTIONS

T <sub>A</sub>	V <sub>I0</sub> max AT 25°C	PACKAGED DEVICES				
		SMALL OUTLINE† (DW)	CHIP CARRIER (FK)	CERAMIC DIP (J)	PLASTIC DIP (N)	CERAMIC FLAT PACK (W)
0°C to 70°C	3 mV 5 mV	TLE2074ACDW TLE2074CDW	—	—	TLE2074ACN TLE2074CN	—
–40°C to 85°C	3 mV 5 mV	TLE2074AIDW TLE2074IDW	—	—	TLE2074AIN TLE2074IN	—
–55°C to 125°C	3 mV 5 mV	—	TLE2074AMFK TLE2074MFK	TLE2074AMJ TLE2074MJ	—	TLE2074AMW TLE2074MW

† The DW packages are available taped and reeled. Add R suffix to device type (e.g., TLE2074ACDWR).

## symbol

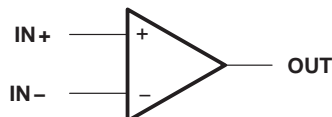

# TLE207x, TLE207xA EXCALIBUR LOW-NOISE HIGH-SPEED JFET-INPUT OPERATIONAL AMPLIFIERS

SLOS181B – FEBRUARY 1997 – REVISED APRIL 2004

**TLE2071 AND TLE2071A  
D, JG, OR P PACKAGE  
(TOP VIEW)**

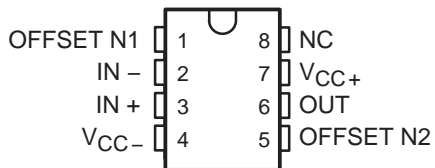

**TLE2072 AND TLE2072A  
D, JG, OR P PACKAGE  
(TOP VIEW)**

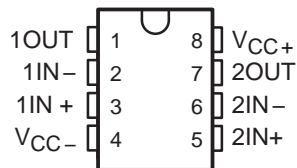

**TLE2074 AND TLE2074A  
J, N, OR W PACKAGE  
(TOP VIEW)**

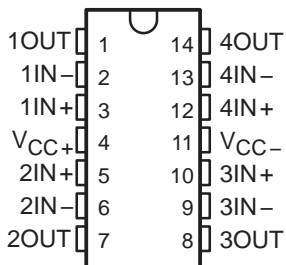

**TLE2074 AND TLE2074A  
DW PACKAGE  
(TOP VIEW)**

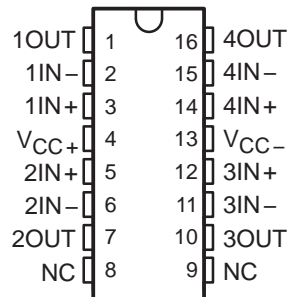

**TLE2071M AND TLE2071AM  
FK PACKAGE  
(TOP VIEW)**

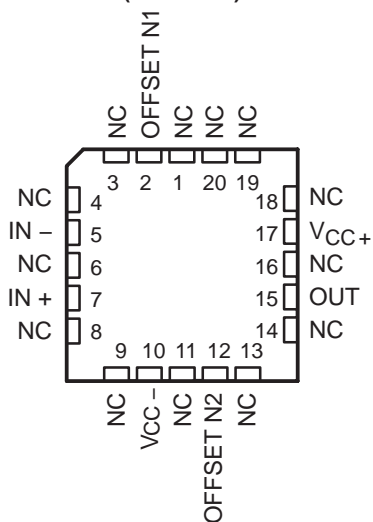

**TLE2072M AND TLE2072AM  
FK PACKAGE  
(TOP VIEW)**

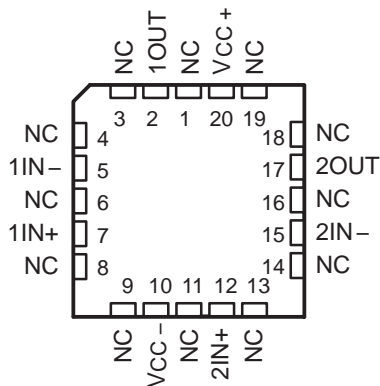

**TLE2074M AND TLE2074AM  
FK PACKAGE  
(TOP VIEW)**

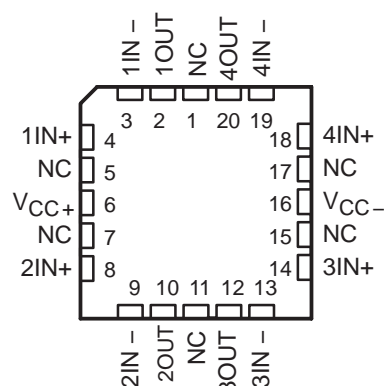

**TLE2071 AND TLE2071A  
U PACKAGE  
(TOP VIEW)**

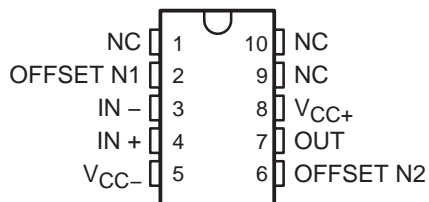

**TLE2072 AND TLE2072A  
U PACKAGE  
(TOP VIEW)**

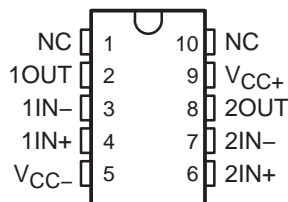

NC – No internal connection

# TLE207x, TLE207xA EXCALIBUR LOW-NOISE HIGH-SPEED JFET-INPUT OPERATIONAL AMPLIFIERS

SLOS181B - FEBRUARY 1997 - REVISED APRIL 2004

equivalent schematic

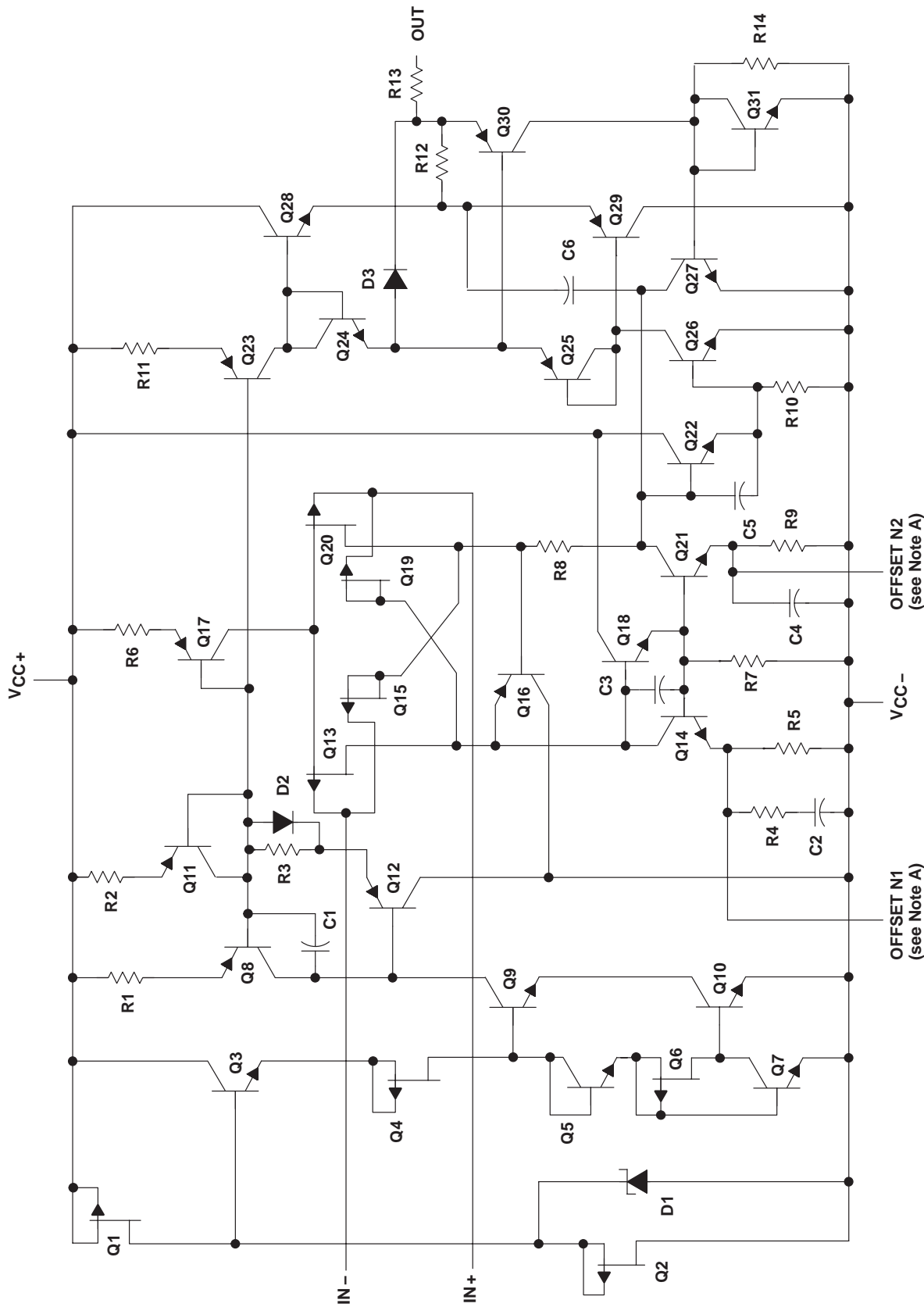

NOTES: A. OFFSET N1 AND OFFSET N2 are only available on the TLE2071x devices.

equivalent schematic (continued)

ACTUAL DEVICE COMPONENT COUNT			
COMPONENT	TLE2071	TLE2072	TLE2074
Transistors	33	57	114
Resistors	25	37	74
Diodes	8	5	10
Capacitors	6	11	22

# TLE207x, TLE207xA

## EXCALIBUR LOW-NOISE HIGH-SPEED

### JFET-INPUT OPERATIONAL AMPLIFIERS

SLOS181B – FEBRUARY 1997 – REVISED APRIL 2004

#### absolute maximum ratings over operating free-air temperature range (unless otherwise noted)†

Supply voltage, $V_{CC+}$ (see Note 1)	19 V
Supply voltage, $V_{CC-}$ (see Note 1)	-19 V
Differential input voltage range, $V_{ID}$ (see Note 2)	$V_{CC+}$ to $V_{CC-}$
Input voltage range, $V_I$ (any input)	$V_{CC+}$ to $V_{CC-}$
Input current, $I_I$ (each input)	$\pm 1$ mA
Output current, $I_O$ (each output)	$\pm 80$ mA
Total current into $V_{CC+}$	160 mA
Total current out of $V_{CC-}$	160 mA
Duration of short-circuit current at (or below) 25°C (see Note 3)	unlimited
Package thermal impedance, $\theta_{JA}$ (see Notes 4 and 5):	
D package	97.1°C/W
DW package	57.3°C/W
N package	79.7°C/W
P package	84.6°C/W
Package thermal impedance, $\theta_{JC}$ (see Notes 4 and 5):	
FK package	5.6°C/W
J package	15.1°C/W
JG package	14.5°C/W
U package	14.7°C/W
W package	10°C/W
Operating free-air temperature range, $T_A$ :	
C suffix	0°C to 70°C
I suffix	-40°C to 85°C
M suffix	-55°C to 125°C
Storage temperature range	-65°C to 150°C
Case temperature for 60 seconds: FK package	260°C
Lead temperature 1,6 mm (1/16 inch) from case for 10 seconds: DW or N package	260°C
Lead temperature 1,6 mm (1/16 inch) from case for 60 seconds: J, JG, U, or W package	300°C

† Stresses beyond those listed under “absolute maximum ratings” may cause permanent damage to the device. These are stress ratings only, and functional operation of the device at these or any other conditions beyond those indicated under “recommended operating conditions” is not implied. Exposure to absolute-maximum-rated conditions for extended periods may affect device reliability.

- NOTES:
1. All voltage values, except differential voltages, are with respect to the midpoint between  $V_{CC+}$  and  $V_{CC-}$ .
  2. Differential voltages are at the noninverting input with respect to the inverting input.
  3. The output may be shorted to either supply. Temperatures and/or supply voltages must be limited to ensure that the maximum dissipation rate is not exceeded.
  4. Maximum power dissipation is a function of  $T_J(\text{max})$ ,  $\theta_{JA}$ , and  $T_A$ . The maximum allowable power dissipation at any allowable ambient temperature is  $P_D = (T_J(\text{max}) - T_A)/\theta_{JA}$ . Operating at the absolute maximum  $T_J$  of 150°C can affect reliability.
  5. The package thermal impedance is calculated in accordance with JEDEC 51-7 (plastic) or MIL-STD-883 Method 1012 (ceramic).

#### recommended operating conditions

		C SUFFIX		I SUFFIX		M SUFFIX		UNIT
		MIN	MAX	MIN	MAX	MIN	MAX	
Supply voltage, $V_{CC\pm}$		$\pm 2.25$	$\pm 19$	$\pm 2.25$	$\pm 19$	$\pm 2.25$	$\pm 19$	V
Common-mode input voltage, $V_{IC}$	$V_{CC\pm} = \pm 5$ V	-0.9	5	-0.8	5	-0.8	5	V
	$V_{CC\pm} = \pm 15$ V	-10.9	15	-10.8	15	-10.8	15	
Operating free-air temperature, $T_A$		0	70	-40	85	-55	125	°C



**TLE207x, TLE207xA**  
**EXCALIBUR LOW-NOISE HIGH-SPEED**  
**JFET-INPUT OPERATIONAL AMPLIFIERS**

SLOS181B – FEBRUARY 1997 – REVISED APRIL 2004

**TLE2071C electrical characteristics at specified free-air temperature,  $V_{CC\pm} = \pm 5\text{ V}$  (unless otherwise noted)**

PARAMETER	TEST CONDITIONS	$T_A$ †	TLE2071C			TLE2071AC			UNIT	
			MIN	TYP	MAX	MIN	TYP	MAX		
$V_{IO}$ Input offset voltage	$V_{IC} = 0, V_O = 0,$ $R_S = 50\ \Omega$	25°C	0.34	4		0.3	2	mV		
		Full range			6		4			
$\alpha_{VIO}$ Temperature coefficient of input offset voltage		Full range	3.2	29		3.2	29	$\mu\text{V}/^\circ\text{C}$		
$I_{IO}$ Input offset current	$V_{IC} = 0, V_O = 0,$ See Figure 4	25°C	5	100		5	100	pA		
		Full range			1.4		1.4	nA		
$I_{IB}$ Input bias current		25°C	15	175		15	175	pA		
		Full range			5		5	nA		
$V_{ICR}$ Common-mode input voltage range	$R_S = 50\ \Omega$	25°C	5 to -1	5 to -1.9		5 to -1	5 to -1.9	V		
		Full range	5 to -0.9			5 to -0.9				
$V_{OM+}$ Maximum positive peak output voltage swing	$I_O = -200\ \mu\text{A}$	25°C	3.8	4.1		3.8	4.1	V		
		Full range	3.7			3.7				
	$I_O = -2\ \text{mA}$	25°C	3.5	3.9		3.5	3.9			
		Full range	3.4			3.4				
	$I_O = -20\ \text{mA}$	25°C	1.5	2.3		1.5	2.3			
		Full range	1.5			1.5				
$V_{OM-}$ Maximum negative peak output voltage swing	$I_O = 200\ \mu\text{A}$	25°C	-3.5	-4.2		-3.5	-4.2	V		
		Full range	-3.4			-3.4				
	$I_O = 2\ \text{mA}$	25°C	-3.7	-4.1		-3.7	-4.1			
		Full range	-3.6			-3.6				
	$I_O = 20\ \text{mA}$	25°C	-1.5	-2.4		-1.5	-2.4			
		Full range	-1.5			-1.5				
$A_{VD}$ Large-signal differential voltage amplification	$V_O = \pm 2.3\ \text{V}$	$R_L = 600\ \Omega$	25°C	80	91		80	91	dB	
			Full range	79			79			
		$R_L = 2\ \text{k}\Omega$	25°C	90	100		90	100		
			Full range	89			89			
		$R_L = 10\ \text{k}\Omega$	25°C	95	106		95	106		
			Full range	94			94			
$r_i$ Input resistance	$V_{IC} = 0$	25°C	$10^{12}$			$10^{12}$			$\Omega$	
$c_i$ Input capacitance	$V_{IC} = 0,$ See Figure 5	Common mode	25°C	11			11			pF
		Differential	25°C	2.5			2.5			
$z_o$ Open-loop output impedance	$f = 1\ \text{MHz}$	25°C	80			80			$\Omega$	
CMRR Common-mode rejection ratio	$V_{IC} = V_{ICRmin},$ $V_O = 0,$ $R_S = 50\ \Omega$	25°C	70	89		70	89	dB		
		Full range	68			68				
$k_{SVR}$ Supply-voltage rejection ratio ( $\Delta V_{CC\pm} / \Delta V_{IO}$ )	$V_{CC\pm} = \pm 5\ \text{V}$ to $\pm 15\ \text{V},$ $V_O = 0,$ $R_S = 50\ \Omega$	25°C	82	99		82	99	dB		
		Full range	80			80				

† Full range is 0°C to 70°C.



# TLE207x, TLE207xA EXCALIBUR LOW-NOISE HIGH-SPEED JFET-INPUT OPERATIONAL AMPLIFIERS

SLOS181B – FEBRUARY 1997 – REVISED APRIL 2004

**TLE2071C electrical characteristics at specified free-air temperature,  $V_{CC\pm} = \pm 5\text{ V}$  (unless otherwise noted) (continued)**

PARAMETER	TEST CONDITIONS	$T_A$ †	TLE2071C			TLE2071AC			UNIT
			MIN	TYP	MAX	MIN	TYP	MAX	
$I_{CC}$ Supply current	$V_O = 0$ , No load	25°C	1.35	1.6	2.2	1.35	1.6	2.2	mA
		Full range				2.2			
$I_{OS}$ Short-circuit output current	$V_O = 0$	25°C	$V_{ID} = 1\text{ V}$			-35			mA
			$V_{ID} = -1\text{ V}$			45			

† Full range is 0°C to 70°C.

**TLE2071C operating characteristics at specified free-air temperature,  $V_{CC\pm} = \pm 5\text{ V}$**

PARAMETER	TEST CONDITIONS	$T_A$ †	TLE2071C			TLE2071AC			UNIT
			MIN	TYP	MAX	MIN	TYP	MAX	
SR+ Positive slew rate	$V_{O(PP)} = \pm 2.3\text{ V}$ , $A_{VD} = -1$ , $R_L = 2\text{ k}\Omega$ , $C_L = 100\text{ pF}$ , See Figure 1	25°C	35			35			V/ $\mu\text{s}$
		Full range	23			23			
SR- Negative slew rate		25°C	38			38			V/ $\mu\text{s}$
		Full range	23			23			
$t_s$ Settling time	$A_{VD} = -1$ , 2-V step, $R_L = 1\text{ k}\Omega$ , $C_L = 100\text{ pF}$	25°C	To 10 mV	0.25		0.25		$\mu\text{s}$	
			To 1 mV	0.4		0.4			
$V_n$ Equivalent input noise voltage	$R_S = 20\ \Omega$ , See Figure 3	25°C	f = 10 Hz	28	55	28	55	nV/ $\sqrt{\text{Hz}}$	
			f = 10 kHz	11.6	17	11.6	17		
$V_{N(PP)}$ Peak-to-peak equivalent input noise voltage		25°C	f = 10 Hz to 10 kHz	6		6		$\mu\text{V}$	
			f = 0.1 Hz to 10 Hz	0.6		0.6			
$I_n$ Equivalent input noise current	$V_{IC} = 0$ , f = 10 kHz	25°C	2.8		2.8		fA/ $\sqrt{\text{Hz}}$		
THD + N Total harmonic distortion plus noise	$V_{O(PP)} = 5\text{ V}$ , f = 1 kHz, $R_S = 25\ \Omega$	$A_{VD} = 10$ , $R_L = 2\text{ k}\Omega$ ,	25°C	0.013%		0.013%			
$B_1$ Unity-gain bandwidth	$V_I = 10\text{ mV}$ , $C_L = 25\text{ pF}$ ,	$R_L = 2\text{ k}\Omega$ , See Figure 2	25°C	9.4		9.4		MHz	
$B_{OM}$ Maximum output-swing bandwidth	$V_{O(PP)} = 4\text{ V}$ , $R_L = 2\text{ k}\Omega$ ,	$A_{VD} = -1$ , $C_L = 25\text{ pF}$	25°C	2.8		2.8		MHz	
$\phi_m$ Phase margin at unity gain	$V_I = 10\text{ mV}$ , $C_L = 25\text{ pF}$ ,	$R_L = 2\text{ k}\Omega$ , See Figure 2	25°C	56°		56°			

† Full range is 0°C to 70°C.





**TLE207x, TLE207xA**  
**EXCALIBUR LOW-NOISE HIGH-SPEED**  
**JFET-INPUT OPERATIONAL AMPLIFIERS**

SLOS181B – FEBRUARY 1997 – REVISED APRIL 2004

**TLE2071C electrical characteristics at specified free-air temperature,  $V_{CC\pm} = \pm 15\text{ V}$  (unless otherwise noted)**

PARAMETER	TEST CONDITIONS	$T_A$ †	TLE2071C			TLE2071AC			UNIT	
			MIN	TYP	MAX	MIN	TYP	MAX		
$V_{IO}$ Input offset voltage	$V_{IC} = 0,$ $R_S = 50\ \Omega$ $V_O = 0,$	25°C	0.49	4		0.47	2	mV		
		Full range			6		4			
$\alpha_{VIO}$ Temperature coefficient of input offset voltage		Full range	3.2	29		3.2	29	$\mu\text{V}/^\circ\text{C}$		
$I_{IO}$ Input offset current	$V_{IC} = 0,$ $V_O = 0,$ See Figure 4	25°C	6	100		6	100	pA		
		Full range		1.4		1.4		nA		
$I_{IB}$ Input bias current		25°C	20	175		20	175	pA		
		Full range		5		5		nA		
$V_{ICR}$ Common-mode input voltage range	$R_S = 50\ \Omega$	25°C	15 to -11	15 to -11.9		15 to -11	15 to -11.9	V		
		Full range	15 to -10.9		15 to -10.9					
$V_{OM+}$ Maximum positive peak output voltage swing	$I_O = -200\ \mu\text{A}$	25°C	13.8	14.1		13.8	14.1	V		
		Full range	13.7		13.7					
	$I_O = -2\ \text{mA}$	25°C	13.5	13.9		13.5	13.9			
		Full range	13.4		13.4					
	$I_O = -20\ \text{mA}$	25°C	11.5	12.3		11.5	12.3			
		Full range	11.5		11.5					
$V_{OM-}$ Maximum negative peak output voltage swing	$I_O = 200\ \mu\text{A}$	25°C	-13.8	-14.2		-13.8	-14.2	V		
		Full range	-13.7		-13.7					
	$I_O = 2\ \text{mA}$	25°C	-13.5	-14		-13.5	-14			
		Full range	-13.4		-13.4					
	$I_O = 20\ \text{mA}$	25°C	-11.5	-12.4		-11.5	-12.4			
		Full range	-11.5		-11.5					
$A_{VD}$ Large-signal differential voltage amplification	$V_O = \pm 10\ \text{V}$	$R_L = 600\ \Omega$	25°C	80	96		80	96	dB	
			Full range	79		79				
		$R_L = 2\ \text{k}\Omega$	25°C	90	109		90	109		
			Full range	89		89				
		$R_L = 10\ \text{k}\Omega$	25°C	95	118		95	118		
			Full range	94		94				
$r_i$ Input resistance	$V_{IC} = 0$	25°C	$10^{12}$			$10^{12}$			$\Omega$	
$c_i$ Input capacitance	$V_{IC} = 0,$ See Figure 5	Common mode	25°C	7.5			7.5			pF
		Differential	25°C	2.5			2.5			
$z_o$ Open-loop output impedance	$f = 1\ \text{MHz}$	25°C	80			80			$\Omega$	
CMRR Common-mode rejection ratio	$V_{IC} = V_{ICRmin},$ $V_O = 0,$ $R_S = 50\ \Omega$	25°C	80	98		80	98	dB		
		Full range	79		79					
$k_{SVR}$ Supply-voltage rejection ratio ( $\Delta V_{CC\pm}/\Delta V_{IO}$ )	$V_{CC\pm} = \pm 5\ \text{V to } \pm 15\ \text{V},$ $V_O = 0,$ $R_S = 50\ \Omega$	25°C	82	99		82	99	dB		
		Full range	80		81					

† Full range is 0°C to 70°C.



# TLE207x, TLE207xA EXCALIBUR LOW-NOISE HIGH-SPEED JFET-INPUT OPERATIONAL AMPLIFIERS

SLOS181B – FEBRUARY 1997 – REVISED APRIL 2004

**TLE2071C electrical characteristics at specified free-air temperature,  $V_{CC\pm} = \pm 15$  V (unless otherwise noted) (continued)**

PARAMETER	TEST CONDITIONS	$T_A$ †	TLE2071C			TLE2071AC			UNIT
			MIN	TYP	MAX	MIN	TYP	MAX	
$I_{CC}$ Supply current	$V_O = 0$ , No load	25°C	1.35	1.7	2.2	1.35	1.7	2.2	mA
		Full range	2.2			2.2			
$I_{OS}$ Short-circuit output current	$V_O = 0$	25°C	$V_{ID} = 1$ V	-30	-45	-30	-45	mA	
			$V_{ID} = -1$ V	30	48	30	48		

† Full range is 0°C to 70°C.

**TLE2071C operating characteristics at specified free-air temperature,  $V_{CC\pm} = \pm 15$  V**

PARAMETER	TEST CONDITIONS	$T_A$ †	TLE2071C			TLE2071AC			UNIT
			MIN	TYP	MAX	MIN	TYP	MAX	
SR+ Positive slew rate	$V_{O(PP)} = 10$ V, $A_{VD} = -1$ , $R_L = 2$ k $\Omega$ , $C_L = 100$ pF, See Figure 1	25°C	30	40		30	40	V/ $\mu$ s	
		Full range	27			27			
SR- Negative slew rate		25°C	30	45		30	45	V/ $\mu$ s	
		Full range	27			27			
$t_s$ Settling time	$A_{VD} = -1$ , 10-V step, $R_L = 1$ k $\Omega$ , $C_L = 100$ pF	25°C	To 10 mV			0.4			$\mu$ s
			To 1 mV			1.5			
$V_n$ Equivalent input noise voltage	$R_S = 20$ $\Omega$ , See Figure 3	25°C	f = 10 Hz	28	55	28	55	nV/ $\sqrt{\text{Hz}}$	
			f = 10 kHz	11.6	17	11.6	17		
$V_{N(PP)}$ Peak-to-peak equivalent input noise voltage		25°C	f = 10 Hz to 10 kHz			6			$\mu$ V
			f = 0.1 Hz to 10 Hz			0.6			
$I_n$ Equivalent input noise current	$V_{IC} = 0$ , f = 10 kHz	25°C	2.8			2.8			fA/ $\sqrt{\text{Hz}}$
THD + N Total harmonic distortion plus noise	$V_{O(PP)} = 20$ V, $A_{VD} = 10$ , f = 1 kHz, $R_L = 2$ k $\Omega$ , $R_S = 25$ $\Omega$	25°C	0.008%			0.008%			
$B_1$ Unity-gain bandwidth	$V_I = 10$ mV, $R_L = 2$ k $\Omega$ , $C_L = 25$ pF, See Figure 2	25°C	8	10		8	10	MHz	
$B_{OM}$ Maximum output-swing bandwidth	$V_{O(PP)} = 20$ V, $A_{VD} = -1$ , $R_L = 2$ k $\Omega$ , $C_L = 25$ pF	25°C	478	637		478	637	kHz	
$\phi_m$ Phase margin at unity gain	$V_I = 10$ mV, $R_L = 2$ k $\Omega$ , $C_L = 25$ pF, See Figure 2	25°C	57°			57°			

† Full range is 0°C to 70°C.



**TLE207x, TLE207xA**  
**EXCALIBUR LOW-NOISE HIGH-SPEED**  
**JFET-INPUT OPERATIONAL AMPLIFIERS**

SLOS181B – FEBRUARY 1997 – REVISED APRIL 2004

**TLE20711 electrical characteristics at specified free-air temperature,  $V_{CC\pm} = \pm 5\text{ V}$  (unless otherwise noted)**

PARAMETER	TEST CONDITIONS	$T_A$ †	TLE20711			TLE2071AI			UNIT	
			MIN	TYP	MAX	MIN	TYP	MAX		
$V_{IO}$ Input offset voltage	$V_{IC} = 0,$ $R_S = 50\ \Omega,$ $V_O = 0,$	25°C	0.34	4		0.3	2	mV		
		Full range			7.6		5.6			
$\alpha_{VIO}$ Temperature coefficient of input offset voltage		Full range	3.2	29		3.2	29	$\mu\text{V}/^\circ\text{C}$		
$I_{IO}$ Input offset current	$V_{IC} = 0,$ $V_O = 0,$ See Figure 4	25°C	5	100		5	100	pA		
		Full range			5		5	nA		
$I_{IB}$ Input bias current		25°C	15	175		15	175	pA		
		Full range			10		10	nA		
$V_{ICR}$ Common-mode input voltage range	$R_S = 50\ \Omega$	25°C	5 to -1	5 to -1.9		5 to -1	5 to -1.9	V		
		Full range	5 to -0.8			5 to -0.8				
$V_{OM+}$ Maximum positive peak output voltage swing	$I_O = -200\ \mu\text{A}$	25°C	3.8	4.1		3.8	4.1	V		
		Full range	3.7			3.7				
	$I_O = -2\ \text{mA}$	25°C	3.5	3.9		3.5	3.9			
		Full range	3.4			3.4				
$I_O = -20\ \text{mA}$	25°C	1.5	2.3		1.5	2.3				
	Full range	1.5			1.5					
$V_{OM-}$ Maximum negative peak output voltage swing	$I_O = 200\ \mu\text{A}$	25°C	-3.8	-4.2		-3.8	-4.2	V		
		Full range	-3.7			-3.7				
	$I_O = 2\ \text{mA}$	25°C	-3.5	-4.1		-3.5	-4.1			
		Full range	-3.4			-3.4				
$I_O = 20\ \text{mA}$	25°C	-1.5	-2.4		-1.5	-2.4				
	Full range	-1.5			-1.5					
$A_{VD}$ Large-signal differential voltage amplification	$V_O = \pm 2.3\ \text{V}$	$R_L = 600\ \Omega$	25°C	80	91		80	91	dB	
			Full range	79			79			
		$R_L = 2\ \text{k}\Omega$	25°C	90	100		90	100		
			Full range	89			89			
		$R_L = 10\ \text{k}\Omega$	25°C	95	106		95	106		
			Full range	94			94			
$r_i$ Input resistance	$V_{IC} = 0$	25°C	$10^{12}$			$10^{12}$			$\Omega$	
$c_i$ Input capacitance	$V_{IC} = 0,$ See Figure 5	Common mode	25°C	11			11			pF
		Differential	25°C	2.5			2.5			
$z_o$ Open-loop output impedance	$f = 1\ \text{MHz}$	25°C	80			80			$\Omega$	
CMRR Common-mode rejection ratio	$V_{IC} = V_{ICRmin},$ $V_O = 0,$ $R_S = 50\ \Omega$	25°C	70	89		70	89	dB		
		Full range	68			68				
$k_{SVR}$ Supply-voltage rejection ratio ( $\Delta V_{CC\pm}/\Delta V_{IO}$ )	$V_{CC\pm} = \pm 5\ \text{V}$ to $\pm 15\ \text{V},$ $V_O = 0,$ $R_S = 50\ \Omega$	25°C	82	99		82	99	dB		
		Full range	80			80				

† Full range is  $-40^\circ\text{C}$  to  $85^\circ\text{C}$ .



# TLE207x, TLE207xA EXCALIBUR LOW-NOISE HIGH-SPEED JFET-INPUT OPERATIONAL AMPLIFIERS

SLOS181B – FEBRUARY 1997 – REVISED APRIL 2004

**TLE2071I electrical characteristics at specified free-air temperature,  $V_{CC\pm} = \pm 5\text{ V}$  (unless otherwise noted) (continued)**

PARAMETER	TEST CONDITIONS	$T_A$ †	TLE2071I			TLE2071AI			UNIT
			MIN	TYP	MAX	MIN	TYP	MAX	
$I_{CC}$ Supply current	$V_O = 0$ , No load	25°C	1.35	1.6	2.2	1.35	1.6	2.2	mA
		Full range	2.2			2.2			
$I_{OS}$ Short-circuit output current	$V_O = 0$	25°C	$V_{ID} = 1\text{ V}$			-35			mA
			$V_{ID} = -1\text{ V}$			45			

† Full range is  $-40^\circ\text{C}$  to  $85^\circ\text{C}$ .

**TLE2071I operating characteristics at specified free-air temperature,  $V_{CC\pm} = \pm 5\text{ V}$**

PARAMETER	TEST CONDITIONS	$T_A$ †	TLE2071I			TLE2071AI			UNIT
			MIN	TYP	MAX	MIN	TYP	MAX	
SR+ Positive slew rate	$V_{O(PP)} = \pm 2.3\text{ V}$ , $A_{VD} = -1$ , $R_L = 2\text{ k}\Omega$ , $C_L = 100\text{ pF}$ , See Figure 1	25°C	35			35			V/ $\mu\text{s}$
		Full range	22			22			
SR- Negative slew rate		25°C	38			38			V/ $\mu\text{s}$
		Full range	22			22			
$t_s$ Settling time	$A_{VD} = -1$ , 2-V step, $R_L = 1\text{ k}\Omega$ , $C_L = 100\text{ pF}$	25°C	To 10 mV			0.25			$\mu\text{s}$
			To 1 mV			0.4			
$V_n$ Equivalent input noise voltage	$R_S = 20\ \Omega$ , See Figure 3	25°C	f = 10 Hz		28		55		nV/ $\sqrt{\text{Hz}}$
			f = 10 kHz		11.6		17		
$V_{N(PP)}$ Peak-to-peak equivalent input noise voltage		25°C	f = 10 Hz to 10 kHz		6		6		$\mu\text{V}$
			f = 0.1 Hz to 10 Hz		0.6		0.6		
$I_n$ Equivalent input noise current	$V_{IC} = 0$ , f = 10 kHz	25°C	2.8			2.8			fA/ $\sqrt{\text{Hz}}$
THD + N Total harmonic distortion plus noise	$V_{O(PP)} = 5\text{ V}$ , $A_{VD} = 10$ , f = 1 kHz, $R_L = 2\text{ k}\Omega$ , $R_S = 25\ \Omega$	25°C	0.013%			0.013%			
$B_1$ Unity-gain bandwidth	$V_I = 10\text{ mV}$ , $R_L = 2\text{ k}\Omega$ , $C_L = 25\text{ pF}$ , See Figure 2	25°C	9.4			9.4			MHz
$B_{OM}$ Maximum output-swing bandwidth	$V_{O(PP)} = 4\text{ V}$ , $A_{VD} = -1$ , $R_L = 2\text{ k}\Omega$ , $C_L = 25\text{ pF}$	25°C	2.8			2.8			MHz
$\phi_m$ Phase margin at unity gain	$V_I = 10\text{ mV}$ , $R_L = 2\text{ k}\Omega$ , $C_L = 25\text{ pF}$ , See Figure 2	25°C	56°			56°			

† Full range is  $-40^\circ\text{C}$  to  $85^\circ\text{C}$ .



**TLE207x, TLE207xA**  
**EXCALIBUR LOW-NOISE HIGH-SPEED**  
**JFET-INPUT OPERATIONAL AMPLIFIERS**

SLOS181B – FEBRUARY 1997 – REVISED APRIL 2004

**TLE20711 electrical characteristics at specified free-air temperature,  $V_{CC\pm} = \pm 15\text{ V}$  (unless otherwise noted)**

PARAMETER	TEST CONDITIONS	$T_A$ †	TLE20711			TLE2071AI			UNIT	
			MIN	TYP	MAX	MIN	TYP	MAX		
$V_{IO}$ Input offset voltage	$V_{IC} = 0,$ $V_O = 0,$ $R_S = 50\ \Omega,$	25°C	0.49	4		0.47	2	mV		
		Full range			7.6		5.6			
$\alpha_{VIO}$ Temperature coefficient of input offset voltage		Full range	3.2	29		3.2	29	$\mu\text{V}/^\circ\text{C}$		
$I_{IO}$ Input offset current	$V_{IC} = 0,$ $V_O = 0,$ See Figure 4	25°C	6	100		6	100	pA		
		Full range			5		5	nA		
$I_{IB}$ Input bias current		25°C	20	175		20	175	pA		
		Full range			10		10	nA		
$V_{ICR}$ Common-mode input voltage range	$R_S = 50\ \Omega$	25°C	15 to -11	15 to -11.9		15 to -11	15 to -11.9	V		
		Full range	15 to -10.8			15 to -10.8				
$V_{OM+}$ Maximum positive peak output voltage swing	$I_O = -200\ \mu\text{A}$ $I_O = -2\ \text{mA}$ $I_O = -20\ \text{mA}$	25°C	13.8	14.1		13.8	14.1	V		
		Full range	13.7			13.7				
		25°C	13.5	13.9		13.5	13.9			
		Full range	13.4			13.4				
$V_{OM-}$ Maximum negative peak output voltage swing	$I_O = 200\ \mu\text{A}$ $I_O = 2\ \text{mA}$ $I_O = 20\ \text{mA}$	25°C	-13.8	-14.2		-13.8	-14.2	V		
		Full range	-13.7			-13.7				
		25°C	-13.5	-14		-13.5	-14			
		Full range	-13.4			-13.4				
$A_{VD}$ Large-signal differential voltage amplification	$V_O = \pm 10\ \text{V}$	$R_L = 600\ \Omega$	25°C	80	96		80	96	dB	
			Full range	79			79			
		$R_L = 2\ \text{k}\Omega$	25°C	90	109		90	109		
			Full range	89			89			
		$R_L = 10\ \text{k}\Omega$	25°C	95	118		95	118		
			Full range	94			94			
$r_i$ Input resistance	$V_{IC} = 0$	25°C	$10^{12}$			$10^{12}$			$\Omega$	
$c_i$ Input capacitance	$V_{IC} = 0,$ See Figure 5	Common mode	25°C	7.5			7.5			pF
		Differential	25°C	2.5			2.5			
$z_o$ Open-loop output impedance	$f = 1\ \text{MHz}$	25°C	80			80			$\Omega$	
CMRR Common-mode rejection ratio	$V_{IC} = V_{ICRmin},$ $V_O = 0,$ $R_S = 50\ \Omega$	25°C	80	98		80	98	dB		
		Full range	79			79				
$k_{SVR}$ Supply-voltage rejection ratio ( $\Delta V_{CC\pm}/\Delta V_{IO}$ )	$V_{CC\pm} = \pm 5\ \text{V}$ to $\pm 15\ \text{V},$ $V_O = 0,$ $R_S = 50\ \Omega$	25°C	82	99		82	99	dB		
		Full range	80			80				

† Full range is  $-40^\circ\text{C}$  to  $85^\circ\text{C}$ .



# TLE207x, TLE207xA EXCALIBUR LOW-NOISE HIGH-SPEED JFET-INPUT OPERATIONAL AMPLIFIERS

SLOS181B – FEBRUARY 1997 – REVISED APRIL 2004

TLE2071I electrical characteristics at specified free-air temperature,  $V_{CC\pm} = \pm 15\text{ V}$  (unless otherwise noted) (continued)

PARAMETER	TEST CONDITIONS	$T_A$ †	TLE2071I			TLE2071AI			UNIT
			MIN	TYP	MAX	MIN	TYP	MAX	
$I_{CC}$ Supply current	$V_O = 0$ , No load	25°C	1.35	1.7	2.2	1.35	1.7	2.2	mA
		Full range	2.2			2.2			
$I_{OS}$ Short-circuit output current	$V_O = 0$	25°C	$V_{ID} = 1\text{ V}$	-30	-45	-30	-45	mA	
			$V_{ID} = -1\text{ V}$	30	48	30	48		

† Full range is  $-40^\circ\text{C}$  to  $85^\circ\text{C}$ .

TLE2071I operating characteristics at specified free-air temperature,  $V_{CC\pm} = \pm 15\text{ V}$

PARAMETER	TEST CONDITIONS	$T_A$ †	TLE2071I			TLE2071AI			UNIT
			MIN	TYP	MAX	MIN	TYP	MAX	
SR+ Positive slew rate	$V_{O(PP)} = \pm 10\text{ V}$ , $A_{VD} = -1$ , $C_L = 100\text{ pF}$ , $R_L = 2\text{ k}\Omega$ , See Figure 1	25°C	30	40	30	40	V/ $\mu\text{s}$		
		Full range	24			24			
SR- Negative slew rate		25°C	30	45	30	45	V/ $\mu\text{s}$		
		Full range	24			24			
$t_s$ Settling time	$A_{VD} = -1$ , 10-V step, $R_L = 1\text{ k}\Omega$ , $C_L = 100\text{ pF}$	25°C	To 10 mV	0.4		0.4		$\mu\text{s}$	
			To 1 mV	1.5		1.5			
$V_n$ Equivalent input noise voltage	$R_S = 20\ \Omega$ , See Figure 3	25°C	f = 10 Hz	28	55	28	55	nV/ $\sqrt{\text{Hz}}$	
			f = 10 kHz	11.6	17	11.6	17		
$V_{N(PP)}$ Peak-to-peak equivalent input noise voltage		25°C	f = 10 Hz to 10 kHz	6		6		$\mu\text{V}$	
			f = 0.1 Hz to 10 Hz	0.6		0.6			
$I_n$ Equivalent input noise current	$V_{IC} = 0$ , f = 10 kHz	25°C	2.8		2.8		fA/ $\sqrt{\text{Hz}}$		
THD + N Total harmonic distortion plus noise	$V_{O(PP)} = 20\text{ V}$ , f = 1 kHz, $R_S = 25\ \Omega$	$A_{VD} = 10$ , $R_L = 2\text{ k}\Omega$ , 25°C	0.008%		0.008%				
$B_1$ Unity-gain bandwidth	$V_I = 10\text{ mV}$ , $C_L = 25\text{ pF}$ , $R_L = 2\text{ k}\Omega$ , See Figure 2	25°C	8	10	8	10	MHz		
$B_{OM}$ Maximum output-swing bandwidth	$V_{O(PP)} = 20\text{ V}$ , $R_L = 2\text{ k}\Omega$ , $A_{VD} = -1$ , $C_L = 25\text{ pF}$	25°C	478	637	478	637	kHz		
$\phi_m$ Phase margin at unity gain	$V_I = 10\text{ mV}$ , $C_L = 25\text{ pF}$ , $R_L = 2\text{ k}\Omega$ , See Figure 2	25°C	57°		57°				

† Full range is  $-40^\circ\text{C}$  to  $85^\circ\text{C}$ .



**TLE207x, TLE207xA**  
**EXCALIBUR LOW-NOISE HIGH-SPEED**  
**JFET-INPUT OPERATIONAL AMPLIFIERS**

SLOS181B – FEBRUARY 1997 – REVISED APRIL 2004

**TLE2071M electrical characteristics at specified free-air temperature,  $V_{CC\pm} = \pm 5\text{ V}$  (unless otherwise noted)**

PARAMETER	TEST CONDITIONS	$T_A$ †	TLE2071M			TLE2071AM			UNIT	
			MIN	TYP	MAX	MIN	TYP	MAX		
$V_{IO}$ Input offset voltage	$V_{IC} = 0,$ $R_S = 50\ \Omega,$ $V_O = 0,$	25°C	0.34	4		0.3	2	mV		
		Full range			9.2		7.2			
$\alpha_{VIO}$ Temperature coefficient of input offset voltage		Full range	3.2	29‡		3.2	29‡	$\mu\text{V}/^\circ\text{C}$		
$I_{IO}$ Input offset current	$V_{IC} = 0,$ $V_O = 0,$ See Figure 4	25°C	5	100		5	100	pA		
		Full range		20		20		nA		
$I_{IB}$ Input bias current		25°C	15	175		15	175	pA		
		Full range		60		60		nA		
$V_{ICR}$ Common-mode input voltage range	$R_S = 50\ \Omega$	25°C	5 to -1	5 to -1.9		5 to -1	5 to -1.9	V		
		Full range	5 to -0.8		5 to -0.8					
$V_{OM+}$ Maximum positive peak output voltage swing	$I_O = -200\ \mu\text{A}$	25°C	3.8	4.1		3.8	4.1	V		
		Full range	3.6		3.6					
	$I_O = -2\ \text{mA}$	25°C	3.5	3.9		3.5	3.9			
		Full range	3.3		3.3					
	$I_O = -20\ \text{mA}$	25°C	1.5	2.3		1.5	2.3			
		Full range	1.4		1.4					
$V_{OM-}$ Maximum negative peak output voltage swing	$I_O = 200\ \mu\text{A}$	25°C	-3.8	-4.2		-3.8	-4.2	V		
		Full range	-3.6		-3.6					
	$I_O = 2\ \text{mA}$	25°C	-3.5	-4.1		-3.5	-4.1			
		Full range	-3.3		-3.3					
	$I_O = 20\ \text{mA}$	25°C	-1.5	-2.4		-1.5	-2.4			
		Full range	-1.4		-1.4					
$A_{VD}$ Large-signal differential voltage amplification	$V_O = \pm 2.3\ \text{V}$	$R_L = 600\ \Omega$	25°C	80	91		80	91	dB	
			Full range	78		78				
		$R_L = 2\ \text{k}\Omega$	25°C	90	100		90	100		
			Full range	88		88				
		$R_L = 10\ \text{k}\Omega$	25°C	95	106		95	106		
			Full range	93		93				
$r_i$ Input resistance	$V_{IC} = 0$	25°C	$10^{12}$			$10^{12}$			$\Omega$	
$c_i$ Input capacitance	$V_{IC} = 0,$ See Figure 5	Common mode	25°C	11			11			pF
		Differential	25°C	2.5			2.5			
$z_o$ Open-loop output impedance	$f = 1\ \text{MHz}$	25°C	80			80			$\Omega$	
CMRR Common-mode rejection ratio	$V_{IC} = V_{ICRmin},$ $V_O = 0,$ $R_S = 50\ \Omega$	25°C	70	89		70	89	dB		
		Full range	68		68					
$k_{SVR}$ Supply-voltage rejection ratio ( $\Delta V_{CC\pm} / \Delta V_{IO}$ )	$V_{CC\pm} = \pm 5\ \text{V to } \pm 15\ \text{V},$ $V_O = 0,$ $R_S = 50\ \Omega$	25°C	82	99		82	99	dB		
		Full range	80		80					

† Full range is  $-55^\circ\text{C}$  to  $125^\circ\text{C}$ .

‡ \*On products compliant to MIL-PRF-38535, Class B, this parameter is not production tested.



# TLE207x, TLE207xA EXCALIBUR LOW-NOISE HIGH-SPEED JFET-INPUT OPERATIONAL AMPLIFIERS

SLOS181B – FEBRUARY 1997 – REVISED APRIL 2004

**TLE2071M electrical characteristics at specified free-air temperature,  $V_{CC\pm} = \pm 5\text{ V}$  (unless otherwise noted)**

PARAMETER	TEST CONDITIONS	$T_A$ †	TLE2071M			TLE2071AM			UNIT
			MIN	TYP	MAX	MIN	TYP	MAX	
$I_{CC}$ Supply current	$V_O = 0$ , No load	25°C	1.35	1.6	2.2	1.35	1.6	2.2	mA
		Full range				2.2			
$I_{OS}$ Short-circuit output current	$V_O = 0$	25°C	$V_{ID} = 1\text{ V}$			$-35$			mA
			$V_{ID} = -1\text{ V}$			45			

† Full range is  $-55^\circ\text{C}$  to  $125^\circ\text{C}$ .

**TLE2071M operating characteristics at specified free-air temperature,  $V_{CC\pm} = \pm 5\text{ V}$**

PARAMETER	TEST CONDITIONS	$T_A$ †	TLE2071M			TLE2071AM			UNIT	
			MIN	TYP	MAX	MIN	TYP	MAX		
SR+ Positive slew rate	$V_{O(PP)} = \pm 2.3\text{ V}$ , $A_{VD} = -1$ , $R_L = 2\text{ k}\Omega$ , $C_L = 100\text{ pF}$ , See Figure 1	25°C	35			35			$\text{V}/\mu\text{s}$	
		Full range	20‡			20‡				
SR- Negative slew rate		25°C	38			38			$\text{V}/\mu\text{s}$	
		Full range	20‡			20‡				
$t_s$ Settling time	$A_{VD} = -1$ , 2-V step, $R_L = 1\text{ k}\Omega$ , $C_L = 100\text{ pF}$	25°C	To 10 mV			0.25			$\mu\text{s}$	
			To 1 mV			0.4				
$V_n$ Equivalent input noise voltage	$R_S = 20\ \Omega$ , See Figure 3	25°C	$f = 10\text{ Hz}$			28			$\text{nV}/\sqrt{\text{Hz}}$	
			$f = 10\text{ kHz}$			11.6				
$V_{N(PP)}$ Peak-to-peak equivalent input noise voltage		25°C	$f = 10\text{ Hz to } 10\text{ kHz}$			6			$\mu\text{V}$	
			$f = 0.1\text{ Hz to } 10\text{ Hz}$			0.6				
$I_n$ Equivalent input noise current	$V_{IC} = 0$ , $f = 10\text{ kHz}$	25°C	2.8			2.8			$\text{fA}/\sqrt{\text{Hz}}$	
THD + N Total harmonic distortion plus noise	$V_{O(PP)} = 5\text{ V}$ , $f = 1\text{ kHz}$ , $R_S = 25\ \Omega$	$A_{VD} = 10$ , $R_L = 2\text{ k}\Omega$	25°C	0.013%			0.013%			
$B_1$ Unity-gain bandwidth	$V_I = 10\text{ mV}$ , $C_L = 25\text{ pF}$	$R_L = 2\text{ k}\Omega$ , See Figure 2	25°C	9.4			9.4			MHz
$B_{OM}$ Maximum output-swing bandwidth	$V_{O(PP)} = 4\text{ V}$ , $R_L = 2\text{ k}\Omega$	$A_{VD} = -1$ , $C_L = 25\text{ pF}$	25°C	2.8			2.8			MHz
$\phi_m$ Phase margin at unity gain	$V_I = 10\text{ mV}$ , $C_L = 25\text{ pF}$	$R_L = 2\text{ k}\Omega$ , See Figure 2	25°C	56°			56°			

† Full range is  $-55^\circ\text{C}$  to  $125^\circ\text{C}$ .

‡ \*On products compliant to MIL-PRF-38535, Class B, this parameter is not production tested.





**TLE207x, TLE207xA**  
**EXCALIBUR LOW-NOISE HIGH-SPEED**  
**JFET-INPUT OPERATIONAL AMPLIFIERS**

SLOS181B – FEBRUARY 1997 – REVISED APRIL 2004

**TLE2071M electrical characteristics at specified free-air temperature,  $V_{CC\pm} = \pm 15$  V (unless otherwise noted)**

PARAMETER	TEST CONDITIONS	$T_A$ †	TLE2071M			TLE2071AM			UNIT
			MIN	TYP	MAX	MIN	TYP	MAX	
$V_{IO}$ Input offset voltage	$V_{IC} = 0, V_O = 0, R_S = 50 \Omega$	25°C	0.49	4		0.47	2	mV	
		Full range			9.2		7.2		
$\alpha_{VIO}$ Temperature coefficient of input offset voltage		Full range	3.2	29*		3.2	29*	$\mu\text{V}/^\circ\text{C}$	
$I_{IO}$ Input offset current	$V_{IC} = 0, V_O = 0, \text{See Figure 4}$	25°C	6	100		6	100	pA	
		Full range			20		20	nA	
$I_{IB}$ Input bias current		25°C	20	175		20	175	pA	
		Full range			60		60	nA	
$V_{ICR}$ Common-mode input voltage range	$R_S = 50 \Omega$	25°C	15 to -11	15 to -11.9		15 to -11	15 to -11.9	V	
		Full range	15 to -10.9			15 to -10.9			
$V_{OM+}$ Maximum positive peak output voltage swing	$I_O = -200 \mu\text{A}$	25°C	13.8	14.1		13.8	14.1	V	
		Full range	13.6			13.6			
	$I_O = -2 \text{ mA}$	25°C	13.5	13.9		13.5	13.9		
		Full range	13.3			13.3			
	$I_O = -20 \text{ mA}$	25°C	11.5	12.3		11.5	12.3		
		Full range	11.4			11.4			
$V_{OM-}$ Maximum negative peak output voltage swing	$I_O = 200 \mu\text{A}$	25°C	-13.8	-14.2		-13.8	-14.2	V	
		Full range	-13.6			-13.6			
	$I_O = 2 \text{ mA}$	25°C	-13.5	-14		-13.5	-14		
		Full range	-13.3			-13.3			
	$I_O = 20 \text{ mA}$	25°C	-11.5	-12.4		-11.5	-12.4		
		Full range	-11.4			-11.4			
$A_{VD}$ Large-signal differential voltage amplification	$V_O = \pm 10 \text{ V}$	$R_L = 600 \Omega$	25°C	80	96		80	96	dB
			Full range	78			78		
		$R_L = 2 \text{ k}\Omega$	25°C	90	109		90	109	
			Full range	88			88		
		$R_L = 10 \text{ k}\Omega$	25°C	95	118		95	118	
			Full range	93			93		
$r_i$ Input resistance	$V_{IC} = 0$	25°C	10 <sup>12</sup>			10 <sup>12</sup>		$\Omega$	
$c_i$ Input capacitance	$V_{IC} = 0, \text{See Figure 5}$	Common mode	25°C	7.5			7.5		pF
		Differential	25°C	2.5			2.5		
$z_o$ Open-loop output impedance	$f = 1 \text{ MHz}$	25°C	80			80		$\Omega$	
CMRR Common-mode rejection ratio	$V_{IC} = V_{ICRmin}, V_O = 0, R_S = 50 \Omega$	25°C	80	98		80	98	dB	
		Full range	78			78			
$k_{SVR}$ Supply-voltage rejection ratio ( $\Delta V_{CC\pm}/\Delta V_{IO}$ )	$V_{CC\pm} = \pm 5 \text{ V to } \pm 15 \text{ V}, V_O = 0, R_S = 50 \Omega$	25°C	82	99		82	99	dB	
		Full range	80			80			

\*On products compliant to MIL-PRF-38535, Class B, this parameter is not production tested.

† Full range is  $-55^\circ\text{C}$  to  $125^\circ\text{C}$ .



# TLE207x, TLE207xA EXCALIBUR LOW-NOISE HIGH-SPEED JFET-INPUT OPERATIONAL AMPLIFIERS

SLOS181B – FEBRUARY 1997 – REVISED APRIL 2004

**TLE2071M electrical characteristics at specified free-air temperature,  $V_{CC\pm} = \pm 15$  V (unless otherwise noted) (continued)**

PARAMETER	TEST CONDITIONS	$T_A$ †	TLE2071M			TLE2071AM			UNIT
			MIN	TYP	MAX	MIN	TYP	MAX	
$I_{CC}$ Supply current	$V_O = 0$ , No load	25°C	1.35	1.7	2.2	1.35	1.7	2.2	mA
		Full range	2.2			2.2			
$I_{OS}$ Short-circuit output current	$V_O = 0$	25°C	$V_{ID} = 1$ V	-30	-45	-30	-45	mA	
			$V_{ID} = -1$ V	30	48	30	48		

† Full range is  $-55^\circ\text{C}$  to  $125^\circ\text{C}$ .

**TLE2071M operating characteristics at specified free-air temperature,  $V_{CC\pm} = \pm 15$  V**

PARAMETER	TEST CONDITIONS	$T_A$ †	TLE2071M			TLE2071AM			UNIT
			MIN	TYP	MAX	MIN	TYP	MAX	
SR+ Positive slew rate	$V_{O(PP)} = 10$ V, $A_{VD} = -1$ , $R_L = 2$ k $\Omega$ , $C_L = 100$ pF, See Figure 1	25°C	30	40	30	40	V/ $\mu$ s		
		Full range	22			22			
SR- Negative slew rate		25°C	30	45	30	45	V/ $\mu$ s		
		Full range	22			22			
$t_s$ Settling time	$A_{VD} = -1$ , 10-V step, $R_L = 1$ k $\Omega$ , $C_L = 100$ pF	25°C	To 10 mV	0.4		0.4		$\mu$ s	
			To 1 mV	1.5		1.5			
$V_n$ Equivalent input noise voltage	$R_S = 20$ $\Omega$ , See Figure 3	25°C	f = 10 Hz	28	55*	28	55*	nV/ $\sqrt{\text{Hz}}$	
			f = 10 kHz	11.6	17*	11.6	17*		
$V_{N(PP)}$ Peak-to-peak equivalent input noise voltage		25°C	f = 10 Hz to 10 kHz	6		6		$\mu$ V	
			f = 0.1 Hz to 10 Hz	0.6		0.6			
$I_n$ Equivalent input noise current	$V_{IC} = 0$ , f = 10 kHz	25°C	2.8		2.8		fA/ $\sqrt{\text{Hz}}$		
THD + N Total harmonic distortion plus noise	$V_{O(PP)} = 20$ V, $A_{VD} = 10$ , f = 1 kHz, $R_S = 25$ $\Omega$	25°C	0.008%		0.008%				
$B_1$ Unity-gain bandwidth	$V_I = 10$ mV, $R_L = 2$ k $\Omega$ , $C_L = 25$ pF, See Figure 2	25°C	8*	10	8*	10	MHz		
$B_{OM}$ Maximum output-swing bandwidth	$V_{O(PP)} = 20$ V, $A_{VD} = -1$ , $R_L = 2$ k $\Omega$ , $C_L = 25$ pF	25°C	478*	637	478*	637	kHz		
$\phi_m$ Phase margin at unity gain	$V_I = 10$ mV, $R_L = 2$ k $\Omega$ , $C_L = 25$ pF, See Figure 2	25°C	57°		57°				

\*On products compliant to MIL-PRF-38535, Class B, this parameter is not production tested.

† Full range is  $-55^\circ\text{C}$  to  $125^\circ\text{C}$ .



**TLE207x, TLE207xA**  
**EXCALIBUR LOW-NOISE HIGH-SPEED**  
**JFET-INPUT OPERATIONAL AMPLIFIERS**

SLOS181B – FEBRUARY 1997 – REVISED APRIL 2004

**TLE2071Y electrical characteristics at  $V_{CC\pm} = \pm 15\text{ V}$ ,  $T_A = 25^\circ\text{C}$**

PARAMETER		TEST CONDITIONS			TLE2071Y			UNIT
					MIN	TYP	MAX	
$V_{IO}$	Input offset voltage	$V_{IC} = 0$ ,	$V_O = 0$ ,	$R_S = 50\ \Omega$	0.49	4		mV
$I_{IO}$	Input offset current	$V_{IC} = 0$ ,	$V_O = 0$ ,	See Figure 4	6	100		pA
$I_{IB}$	Input bias current				20	175		pA
$V_{ICR}$	Common-mode input voltage range	$R_S = 50\ \Omega$			15 to -11	15 to 11.9		V
$V_{OM+}$	Maximum positive peak output voltage swing	$I_O = -200\ \mu\text{A}$			13.8	14.1		V
		$I_O = -2\ \text{mA}$			13.5	13.9		
		$I_O = -20\ \text{mA}$			11.5	12.3		
$V_{OM-}$	Maximum negative peak output voltage swing	$I_O = 200\ \mu\text{A}$			-13.8	-14.2		V
		$I_O = 2\ \text{mA}$			-13.5	-14		
		$I_O = 20\ \text{mA}$			-11.5	-12.4		
$A_{VD}$	Large-signal differential voltage amplification	$V_O = \pm 10\ \text{V}$	$R_L = 600\ \Omega$		80	96		dB
			$R_L = 2\ \text{k}\Omega$		90	109		
			$R_L = 10\ \text{k}\Omega$		95	118		
$r_i$	Input resistance	$V_{IC} = 0$			$10^{12}$			$\Omega$
$c_i$	Input capacitance	$V_O = 0$ , See Figure 5	Common mode		7.5			pF
			Differential		2.5			
$z_o$	Open-loop output impedance	$f = 1\ \text{MHz}$			80			$\Omega$
CMRR	Common-mode rejection ratio	$V_{IC} = V_{ICRmin}$ , $R_S = 50\ \Omega$	$V_O = 0$ ,		80	98		dB
$k_{SVR}$	Supply-voltage rejection ratio ( $\Delta V_{CC\pm}/\Delta V_{IO}$ )	$V_{CC\pm} = \pm 5\ \text{V}$ to $\pm 15\ \text{V}$ , $R_S = 50\ \Omega$	$V_O = 0$ ,		82	99		dB
$I_{CC}$	Supply current	$V_O = 0$ ,	No load		1.35	1.7	2.2	mA
$I_{OS}$	Short-circuit output current	$V_O = 0$	$V_{ID} = 1\ \text{V}$		-30	-45		mA
			$V_{ID} = -1\ \text{V}$		30	48		

# TLE207x, TLE207xA EXCALIBUR LOW-NOISE HIGH-SPEED JFET-INPUT OPERATIONAL AMPLIFIERS

SLOS181B – FEBRUARY 1997 – REVISED APRIL 2004

**TLE2072C electrical characteristics at specified free-air temperature,  $V_{CC\pm} = \pm 5$  V (unless otherwise noted)**

PARAMETER	TEST CONDITIONS	$T_A$ †	TLE2072C			TLE2072AC			UNIT	
			MIN	TYP	MAX	MIN	TYP	MAX		
$V_{IO}$ Input offset voltage	$V_{IC} = 0, V_O = 0, R_S = 50 \Omega$	25°C	0.9	6		0.65	3.5	mV		
		Full range			7.8		5.3			
$\alpha_{VIO}$ Temperature coefficient of input offset voltage		Full range	2.3	25		2.3	25	$\mu V/^\circ C$		
$I_{IO}$ Input offset current	$V_{IC} = 0, V_O = 0, \text{See Figure 4}$	25°C	5	100		5	100	pA		
		Full range			1.4		1.4	nA		
$I_{IB}$ Input bias current		25°C	15	175		15	175	pA		
		Full range			5		5	nA		
$V_{ICR}$ Common-mode input voltage range	$R_S = 50 \Omega$	25°C	5 to -1	5 to -1.9		5 to -1	5 to -1.9	V		
		Full range	5 to -0.9			5 to -0.9				
$V_{OM+}$ Maximum positive peak output voltage swing	$I_O = -200 \mu A$	25°C	3.8	4.1		3.8	4.1	V		
		Full range	3.7			3.7				
	$I_O = -2 \text{ mA}$	25°C	3.5	3.9		3.5	3.9			
		Full range	3.4			3.4				
	$I_O = -20 \text{ mA}$	25°C	1.5	2.3		1.5	2.3			
		Full range	1.5			1.5				
$V_{OM-}$ Maximum negative peak output voltage swing	$I_O = 200 \mu A$	25°C	-3.8	-4.2		-3.8	-4.2	V		
		Full range	-3.7			-3.7				
	$I_O = 2 \text{ mA}$	25°C	-3.5	-4.1		-3.5	-4.1			
		Full range	-3.4			-3.4				
	$I_O = 20 \text{ mA}$	25°C	-1.5	-2.4		-1.5	-2.4			
		Full range	-1.5			-1.5				
$A_{VD}$ Large-signal differential voltage amplification	$V_O = \pm 2.3 \text{ V}$	$R_L = 600 \Omega$	25°C	80	91		80	91	dB	
			Full range	79			79			
		$R_L = 2 \text{ k}\Omega$	25°C	90	100		90	100		
			Full range	89			89			
		$R_L = 10 \text{ k}\Omega$	25°C	95	106		95	106		
			Full range	94			94			
$r_i$ Input resistance	$V_{IC} = 0$	25°C	$10^{12}$			$10^{12}$			$\Omega$	
$c_i$ Input capacitance	$V_{IC} = 0, \text{See Figure 5}$	Common mode	25°C	11			11			pF
		Differential	25°C	2.5			2.5			
$z_o$ Open-loop output impedance	$f = 1 \text{ MHz}$	25°C	80			80			$\Omega$	
CMRR Common-mode rejection ratio	$V_{IC} = V_{ICRmin}, V_O = 0, R_S = 50 \Omega$	25°C	70	89		70	89	dB		
		Full range	68			68				
$k_{SVR}$ Supply-voltage rejection ratio ( $\Delta V_{CC\pm} / \Delta V_{IO}$ )	$V_{CC\pm} = \pm 5 \text{ V to } \pm 15 \text{ V}, V_O = 0, R_S = 50 \Omega$	25°C	82	99		82	99	dB		
		Full range	80			80				

† Full range is 0°C to 70°C.



**TLE207x, TLE207xA**  
**EXCALIBUR LOW-NOISE HIGH-SPEED**  
**JFET-INPUT OPERATIONAL AMPLIFIERS**

SLOS181B – FEBRUARY 1997 – REVISED APRIL 2004

**TLE2072C electrical characteristics at specified free-air temperature,  $V_{CC\pm} = \pm 5\text{ V}$  (unless otherwise noted)**  
**(continued)**

PARAMETER	TEST CONDITIONS	$T_A$	TLE2072C			TLE2072AC			UNIT	
			MIN	TYP	MAX	MIN	TYP	MAX		
$I_{CC}$	Supply current (both channels)	$V_O = 0$ , No load	25°C	2.7	2.9	3.9	2.7	2.9	3.9	mA
			Full range	3.9			3.9			
$a_x$	Crosstalk attenuation	$V_{IC} = 0$ , $R_L = 2\text{ k}\Omega$	25°C	120			120			dB
$I_{OS}$	Short-circuit output current	$V_O = 0$	25°C	$V_{ID} = 1\text{ V}$			-35			mA
				$V_{ID} = -1\text{ V}$			45			

**TLE2072C operating characteristics at specified free-air temperature,  $V_{CC\pm} = \pm 5\text{ V}$**

PARAMETER	TEST CONDITIONS	$T_A$ †	TLE2072C			TLE2072AC			UNIT		
			MIN	TYP	MAX	MIN	TYP	MAX			
SR+	Positive slew rate	$V_{O(PP)} = \pm 2.3\text{ V}$ , $A_{VD} = -1$ , $C_L = 100\text{ pF}$ , $R_L = 2\text{ k}\Omega$ , See Figure 1	25°C	35			35			V/ $\mu$ s	
			Full range	22			22				
SR-	Negative slew rate		25°C	38			38			V/ $\mu$ s	
			Full range	22			22				
$t_s$	Settling time	$A_{VD} = -1$ , 2-V step, $R_L = 1\text{ k}\Omega$ , $C_L = 100\text{ pF}$	25°C	To 10 mV	0.25			0.25			$\mu$ s
				To 1 mV	0.4			0.4			
$V_n$	Equivalent input noise voltage		25°C	f = 10 Hz	28	55	28	55	nV/ $\sqrt{\text{Hz}}$		
				f = 10 kHz	11.6	17	11.6	17			
$V_{N(PP)}$	Peak-to-peak equivalent input noise voltage	$R_S = 20\ \Omega$ , See Figure 3	25°C	f = 10 Hz to 10 kHz	6			6			$\mu$ V
				f = 0.1 Hz to 10 Hz	0.6			0.6			
$I_n$	Equivalent input noise current	$V_{IC} = 0$ , f = 10 kHz	25°C	2.8			2.8			fA/ $\sqrt{\text{Hz}}$	
THD + N	Total harmonic distortion plus noise	$V_{O(PP)} = 5\text{ V}$ , f = 1 kHz, $R_S = 25\ \Omega$	25°C	0.013%			0.013%				
$B_1$	Unity-gain bandwidth	$V_I = 10\text{ mV}$ , $C_L = 25\text{ pF}$ , $R_L = 2\text{ k}\Omega$ , See Figure 2	25°C	9.4			9.4			MHz	
$B_{OM}$	Maximum output-swing bandwidth	$V_{O(PP)} = 4\text{ V}$ , $R_L = 2\text{ k}\Omega$ , $A_{VD} = -1$ , $C_L = 25\text{ pF}$	25°C	2.8			2.8			MHz	
$\phi_m$	Phase margin at unity gain	$V_I = 10\text{ mV}$ , $C_L = 25\text{ pF}$ , $R_L = 2\text{ k}\Omega$ , See Figure 2	25°C	56°			56°				

† Full range is 0°C to 70°C.

# TLE207x, TLE207xA EXCALIBUR LOW-NOISE HIGH-SPEED JFET-INPUT OPERATIONAL AMPLIFIERS

SLOS181B – FEBRUARY 1997 – REVISED APRIL 2004

**TLE2072C electrical characteristics at specified free-air temperature,  $V_{CC\pm} = \pm 15$  V (unless otherwise noted)**

PARAMETER	TEST CONDITIONS	$T_A$ †	TLE2072C			TLE2072AC			UNIT
			MIN	TYP	MAX	MIN	TYP	MAX	
$V_{IO}$ Input offset voltage	$V_{IC} = 0, V_O = 0, R_S = 50 \Omega$	25°C	1.1	6		0.7	3.5	mV	
		Full range			7.8		5.3		
$\alpha_{VIO}$ Temperature coefficient of input offset voltage		Full range	2.4	25		2.4	25	$\mu\text{V}/^\circ\text{C}$	
$I_{IO}$ Input offset current	$V_{IC} = 0, V_O = 0, \text{See Figure 4}$	25°C	6	100		6	100	pA	
		Full range			1.4		1.4	nA	
$I_{IB}$ Input bias current		25°C	20	175		20	175	pA	
		Full range			5		5	nA	
$V_{ICR}$ Common-mode input voltage range	$R_S = 50 \Omega$	25°C	15 to -11	15 to -11.9		15 to -11	15 to -11.9	V	
		Full range	15 to -10.9			15 to -10.9			
$V_{OM+}$ Maximum positive peak output voltage swing	$I_O = -200 \mu\text{A}$	25°C	13.8	14.1		13.8	14.1	V	
		Full range	13.6			13.6			
	$I_O = -2 \text{ mA}$	25°C	13.5	13.9		13.5	13.9		
		Full range	13.4			13.4			
$I_O = -20 \text{ mA}$	25°C	11.5	12.3		11.5	12.3			
	Full range	11.5			11.5				
$V_{OM-}$ Maximum negative peak output voltage swing	$I_O = 200 \mu\text{A}$	25°C	-13.8	-14.2		-13.8	-14.2	V	
		Full range	-13.7			-13.7			
	$I_O = 2 \text{ mA}$	25°C	-13.5	-14		-13.5	-14		
		Full range	-13.4			-13.4			
$I_O = 20 \text{ mA}$	25°C	-11.5	-12.4		-11.5	-12.4			
	Full range	-11.5			-11.5				
$A_{VD}$ Large-signal differential voltage amplification	$V_O = \pm 10 \text{ V}$	$R_L = 600 \Omega$	25°C	80	96		80	96	dB
			Full range	79			79		
		$R_L = 2 \text{ k}\Omega$	25°C	90	109		90	109	
			Full range	89			89		
		$R_L = 10 \text{ k}\Omega$	25°C	95	118		95	118	
			Full range	94			94		
$r_i$ Input resistance	$V_{IC} = 0$	25°C	10 <sup>12</sup>			10 <sup>12</sup>		$\Omega$	
$c_i$ Input capacitance	$V_{IC} = 0, \text{See Figure 5}$	Common mode	25°C	7.5			7.5		pF
		Differential	25°C	2.5			2.5		
$z_o$ Open-loop output impedance	$f = 1 \text{ MHz}$	25°C	80			80		$\Omega$	
CMRR Common-mode rejection ratio	$V_{IC} = V_{ICRmin}, V_O = 0, R_S = 50 \Omega$	25°C	80	98		80	98	dB	
		Full range	79			79			
$k_{SVR}$ Supply-voltage rejection ratio ( $\Delta V_{CC\pm}/\Delta V_{IO}$ )	$V_{CC\pm} = \pm 5 \text{ V to } \pm 15 \text{ V}, V_O = 0, R_S = 50 \Omega$	25°C	82	99		82	99	dB	
		Full range	81			81			

† Full range is 0°C to 70°C.



**TLE207x, TLE207xA**  
**EXCALIBUR LOW-NOISE HIGH-SPEED**  
**JFET-INPUT OPERATIONAL AMPLIFIERS**

SLOS181B – FEBRUARY 1997 – REVISED APRIL 2004

**TLE2072C electrical characteristics at specified free-air temperature,  $V_{CC\pm} = \pm 15\text{ V}$  (unless otherwise noted) (continued)**

PARAMETER	TEST CONDITIONS	$T_A$	TLE2072C			TLE2072AC			UNIT	
			MIN	TYP	MAX	MIN	TYP	MAX		
$I_{CC}$	Supply current (both channels)	$V_O = 0$ , No load	25°C	2.7	3.1	3.9	2.7	3.1	3.9	mA
			Full range	3.9			3.9			
$a_x$	Crosstalk attenuation	$V_{IC} = 0$ , $R_L = 2\text{ k}\Omega$	25°C	120			120			dB
$I_{OS}$	Short-circuit output current	$V_O = 0$	25°C	$V_{ID} = 1\text{ V}$	-30	-45	-30	-45	mA	
				$V_{ID} = -1\text{ V}$	30	48	30	48		

**TLE2072C operating characteristics at specified free-air temperature,  $V_{CC\pm} = \pm 15\text{ V}$**

PARAMETER	TEST CONDITIONS	$T_A$ †	TLE2072C			TLE2072AC			UNIT
			MIN	TYP	MAX	MIN	TYP	MAX	
SR+	Positive slew rate	$V_{O(PP)} = 10\text{ V}$ , $A_{VD} = -1$ , $C_L = 100\text{ pF}$ , $R_L = 2\text{ k}\Omega$ , See Figure 1	25°C	28	40	28	40	$V/\mu\text{s}$	
			Full range	25			25		
SR-	Negative slew rate	$V_{O(PP)} = 10\text{ V}$ , $A_{VD} = -1$ , $C_L = 100\text{ pF}$ , $R_L = 2\text{ k}\Omega$ , See Figure 1	25°C	30	45	30	45	$V/\mu\text{s}$	
			Full range	25			25		
$t_s$	Settling time	$A_{VD} = -1$ , 10-V step, $R_L = 1\text{ k}\Omega$ , $C_L = 100\text{ pF}$	25°C	To 10 mV	0.4		0.4		$\mu\text{s}$
				To 1 mV	1.5		1.5		
$V_n$	Equivalent input noise voltage	$R_S = 20\ \Omega$ , See Figure 3	25°C	f = 10 Hz	28	55	28	55	$nV/\sqrt{\text{Hz}}$
				f = 10 kHz	11.6	17	11.6	17	
$V_{N(PP)}$	Peak-to-peak equivalent input noise voltage	$R_S = 20\ \Omega$ , See Figure 3	25°C	f = 10 Hz to 10 kHz	6		6		$\mu\text{V}$
				f = 0.1 Hz to 10 Hz	0.6		0.6		
$I_n$	Equivalent input noise current	$V_{IC} = 0$ , f = 10 kHz	25°C	2.8		2.8		$fA/\sqrt{\text{Hz}}$	
THD + N	Total harmonic distortion plus noise	$V_{O(PP)} = 20\text{ V}$ , f = 1 kHz, $R_S = 25\ \Omega$ , $A_{VD} = 10$ , $R_L = 2\text{ k}\Omega$	25°C	0.008%		0.008%			
$B_1$	Unity-gain bandwidth	$V_I = 10\text{ mV}$ , $C_L = 25\text{ pF}$ , $R_L = 2\text{ k}\Omega$ , See Figure 2	25°C	8	10	8	10	MHz	
$B_{OM}$	Maximum output-swing bandwidth	$V_{O(PP)} = 20\text{ V}$ , $R_L = 2\text{ k}\Omega$ , $A_{VD} = -1$ , $C_L = 25\text{ pF}$	25°C	478	637	478	637	kHz	
$\phi_m$	Phase margin at unity gain	$V_I = 10\text{ mV}$ , $C_L = 25\text{ pF}$ , $R_L = 2\text{ k}\Omega$ , See Figure 2	25°C	57°		57°			

† Full range is 0°C to 70°C.



# TLE207x, TLE207xA EXCALIBUR LOW-NOISE HIGH-SPEED JFET-INPUT OPERATIONAL AMPLIFIERS

SLOS181B – FEBRUARY 1997 – REVISED APRIL 2004

TLE2072I electrical characteristics at specified free-air temperature,  $V_{CC\pm} = \pm 5\text{ V}$  (unless otherwise noted)

PARAMETER	TEST CONDITIONS	$T_A$ †	TLE2072I			TLE2072AI			UNIT	
			MIN	TYP	MAX	MIN	TYP	MAX		
$V_{IO}$ Input offset voltage	$V_{IC} = 0, V_O = 0,$ $R_S = 50\ \Omega,$	25°C	0.9	6		0.65	3.5	mV		
		Full range			9.1		6.4			
$\alpha_{VIO}$ Temperature coefficient of input offset voltage		Full range	2.4	25		2.4	25	$\mu\text{V}/^\circ\text{C}$		
$I_{IO}$ Input offset current	$V_{IC} = 0, V_O = 0,$ See Figure 4	25°C	5	100		5	100	pA		
		Full range			5		5	nA		
$I_{IB}$ Input bias current		25°C	15	175		15	175	pA		
		Full range			10		10	nA		
$V_{ICR}$ Common-mode input voltage range	$R_S = 50\ \Omega$	25°C	5 to -1	5 to -1.9		5 to -1	5 to -1.9	V		
		Full range	5 to -0.8			5 to -0.8				
$V_{OM+}$ Maximum positive peak output voltage swing	$I_O = -200\ \mu\text{A}$	25°C	3.8	4.1		3.8	4.1	V		
		Full range	3.7			3.7				
	$I_O = -2\ \text{mA}$	25°C	3.5	3.9		3.5	3.9			
		Full range	3.4			3.4				
	$I_O = -20\ \text{mA}$	25°C	1.5	2.3		1.5	2.3			
		Full range	1.5			1.5				
$V_{OM-}$ Maximum negative peak output voltage swing	$I_O = 200\ \mu\text{A}$	25°C	-3.8	-4.2		-3.8	-4.2	V		
		Full range	-3.7			-3.7				
	$I_O = 2\ \text{mA}$	25°C	-3.5	-4.1		-3.5	-4.1			
		Full range	-3.4			-3.4				
	$I_O = 20\ \text{mA}$	25°C	-1.5	-2.4		-1.5	-2.4			
		Full range	-1.5			-1.5				
$A_{VD}$ Large-signal differential voltage amplification	$V_O = \pm 2.3\ \text{V}$	$R_L = 600\ \Omega$	25°C	80	91		80	91	dB	
			Full range	79			79			
		$R_L = 2\ \text{k}\Omega$	25°C	90	100		90	100		
			Full range	89			89			
		$R_L = 10\ \text{k}\Omega$	25°C	95	106		95	106		
			Full range	94			94			
$r_i$ Input resistance	$V_{IC} = 0$	25°C	$10^{12}$			$10^{12}$			$\Omega$	
$c_i$ Input capacitance	$V_{IC} = 0,$ See Figure 5	Common mode	25°C	11			11			pF
		Differential	25°C	2.5			2.5			
$z_o$ Open-loop output impedance	$f = 1\ \text{MHz}$	25°C	80			80			$\Omega$	
CMRR Common-mode rejection ratio	$V_{IC} = V_{ICRmin}, V_O = 0,$ $R_S = 50\ \Omega$	25°C	70	89		70	89	dB		
		Full range	68			68				
$k_{SVR}$ Supply-voltage rejection ratio ( $\Delta V_{CC\pm}/\Delta V_{IO}$ )	$V_{CC\pm} = \pm 5\ \text{V to } \pm 15\ \text{V}, V_O = 0,$ $R_S = 50\ \Omega$	25°C	82	99		82	99	dB		
		Full range	80			80				

† Full range is  $-40^\circ\text{C}$  to  $85^\circ\text{C}$ .





**TLE207x, TLE207xA**  
**EXCALIBUR LOW-NOISE HIGH-SPEED**  
**JFET-INPUT OPERATIONAL AMPLIFIERS**

SLOS181B – FEBRUARY 1997 – REVISED APRIL 2004

**TLE2072I electrical characteristics at specified free-air temperature,  $V_{CC\pm} = \pm 5\text{ V}$  (unless otherwise noted) (continued)**

PARAMETER	TEST CONDITIONS	$T_A$	TLE2072I			TLE2072AI			UNIT	
			MIN	TYP	MAX	MIN	TYP	MAX		
$I_{CC}$	Supply current (both channels)	$V_O = 0$ , No load	25°C	2.7	2.9	3.9	2.7	2.9	3.9	mA
			Full range	3.9			3.9			
$a_x$	Crosstalk attenuation	$V_{IC} = 0$ , $R_L = 2\text{ k}\Omega$	25°C	120			120			dB
$I_{OS}$	Short-circuit output current	$V_O = 0$	25°C	$V_{ID} = 1\text{ V}$			$-35$			mA
				$V_{ID} = -1\text{ V}$			45			

**TLE2072I operating characteristics at specified free-air temperature,  $V_{CC\pm} = \pm 5\text{ V}$**

PARAMETER	TEST CONDITIONS	$T_A$ †	TLE2072I			TLE2072AI			UNIT	
			MIN	TYP	MAX	MIN	TYP	MAX		
SR+	Positive slew rate	$V_{O(PP)} = \pm 2.3\text{ V}$ , $A_{VD} = -1$ , $C_L = 100\text{ pF}$ , $R_L = 2\text{ k}\Omega$ , See Figure 1	25°C	35			35			V/ $\mu$ s
			Full range	20			20			
SR-	Negative slew rate	$V_{O(PP)} = \pm 2.3\text{ V}$ , $A_{VD} = -1$ , $C_L = 100\text{ pF}$ , $R_L = 2\text{ k}\Omega$ , See Figure 1	25°C	38			38			V/ $\mu$ s
			Full range	20			20			
$t_s$	Settling time	$A_{VD} = -1$ , 2-V step, $R_L = 1\text{ k}\Omega$ , $C_L = 100\text{ pF}$	25°C	To 10 mV			0.25			$\mu$ s
				To 1 mV			0.4			
$V_n$	Equivalent input noise voltage	$R_S = 20\ \Omega$ , See Figure 3	25°C	f = 10 Hz			28			nV/ $\sqrt{\text{Hz}}$
				f = 10 kHz			11.6			
$V_{N(PP)}$	Peak-to-peak equivalent input noise voltage	$R_S = 20\ \Omega$ , See Figure 3	25°C	f = 10 Hz to 10 kHz			6			$\mu$ V
				f = 0.1 Hz to 10 Hz			0.6			
$I_n$	Equivalent input noise current	$V_{IC} = 0$ , f = 10 kHz	25°C	2.8			2.8			fA/ $\sqrt{\text{Hz}}$
THD + N	Total harmonic distortion plus noise	$V_{O(PP)} = 5\text{ V}$ , f = 1 kHz, $R_S = 25\ \Omega$	25°C	0.013%			0.013%			
$B_1$	Unity-gain bandwidth	$V_I = 10\text{ mV}$ , $C_L = 25\text{ pF}$ , $R_L = 2\text{ k}\Omega$ , See Figure 2	25°C	9.4			9.4			MHz
BOM	Maximum output-swing bandwidth	$V_{O(PP)} = 4\text{ V}$ , $R_L = 2\text{ k}\Omega$ , $A_{VD} = -1$ , $C_L = 25\text{ pF}$	25°C	2.8			2.8			MHz
$\phi_m$	Phase margin at unity gain	$V_I = 10\text{ mV}$ , $C_L = 25\text{ pF}$ , $R_L = 2\text{ k}\Omega$ , See Figure 2	25°C	56°			56°			

† Full range is 40°C to 85°C.

# TLE207x, TLE207xA EXCALIBUR LOW-NOISE HIGH-SPEED JFET-INPUT OPERATIONAL AMPLIFIERS

SLOS181B – FEBRUARY 1997 – REVISED APRIL 2004

**TLE2072I electrical characteristics at specified free-air temperature,  $V_{CC\pm} = \pm 15$  V (unless otherwise noted)**

PARAMETER	TEST CONDITIONS	$T_A$ †	TLE2072I			TLE2072AI			UNIT
			MIN	TYP	MAX	MIN	TYP	MAX	
$V_{IO}$ Input offset voltage	$V_{IC} = 0, V_O = 0, R_S = 50 \Omega$	25°C	1.1	6		0.7	3.5	mV	
		Full range			9.1		6.4		
$\alpha_{VIO}$ Temperature coefficient of input offset voltage		Full range	2.4	25		2.4	25	$\mu\text{V}/^\circ\text{C}$	
$I_{IO}$ Input offset current	$V_{IC} = 0, V_O = 0, \text{See Figure 4}$	25°C	6	100		6	100	pA	
		Full range			5		5	nA	
$I_{IB}$ Input bias current		25°C	20	175		20	175	pA	
		Full range			10		10	nA	
$V_{ICR}$ Common-mode input voltage range	$R_S = 50 \Omega$	25°C	15 to -11	15 to -11.9		15 to -11	15 to -11.9	V	
		Full range	15 to -10.8			15 to -10.8			
$V_{OM+}$ Maximum positive peak output voltage swing	$I_O = -200 \mu\text{A}$	25°C	13.8	14.1		13.8	14.1	V	
		Full range	13.7			13.7			
	$I_O = -2 \text{ mA}$	25°C	13.5	13.9		13.5	13.9		
		Full range	13.4			13.4			
	$I_O = -20 \text{ mA}$	25°C	11.5	12.3		11.5	12.3		
		Full range	11.5			11.5			
$V_{OM-}$ Maximum negative peak output voltage swing	$I_O = 200 \mu\text{A}$	25°C	-13.8	-14.2		-13.8	-14.2	V	
		Full range	-13.7			-13.7			
	$I_O = 2 \text{ mA}$	25°C	-13.5	-14		-13.5	-14		
		Full range	-13.4			-13.4			
	$I_O = 20 \text{ mA}$	25°C	-11.5	-12.4		-11.5	-12.4		
		Full range	-11.5			-11.5			
$A_{VD}$ Large-signal differential voltage amplification	$V_O = \pm 10 \text{ V}$	$R_L = 600 \Omega$	25°C	80	96		80	96	dB
			Full range	79			79		
		$R_L = 2 \text{ k}\Omega$	25°C	90	109		90	109	
			Full range	89			89		
		$R_L = 10 \text{ k}\Omega$	25°C	95	118		95	118	
			Full range	94			94		
$r_i$ Input resistance	$V_{IC} = 0$	25°C	10 <sup>12</sup>		10 <sup>12</sup>		$\Omega$		
$c_i$ Input capacitance	$V_{IC} = 0, \text{See Figure 5}$	Common mode	25°C	7.5		7.5		pF	
		Differential	25°C	2.5		2.5			
$z_o$ Open-loop output impedance	$f = 1 \text{ MHz}$	25°C	80		80		$\Omega$		
CMRR Common-mode rejection ratio	$V_{IC} = V_{ICRmin}, V_O = 0, R_S = 50 \Omega$	25°C	80	98		80	98	dB	
		Full range	79			79			
$k_{SVR}$ Supply-voltage rejection ratio ( $\Delta V_{CC\pm}/\Delta V_{IO}$ )	$V_{CC\pm} = \pm 5 \text{ V to } \pm 15 \text{ V}, V_O = 0, R_S = 50 \Omega$	25°C	82	99		82	99	dB	
		Full range	80			80			

† Full range is -40°C to 85°C.



**TLE207x, TLE207xA**  
**EXCALIBUR LOW-NOISE HIGH-SPEED**  
**JFET-INPUT OPERATIONAL AMPLIFIERS**

SLOS181B – FEBRUARY 1997 – REVISED APRIL 2004

**TLE2072I electrical characteristics at specified free-air temperature,  $V_{CC\pm} = \pm 15\text{ V}$  (unless otherwise noted)**  
**(continued)**

PARAMETER	TEST CONDITIONS	$T_A$	TLE2072I			TLE2072AI			UNIT	
			MIN	TYP	MAX	MIN	TYP	MAX		
$I_{CC}$	Supply current (both channels)	$V_O = 0$ , No load	25°C	2.7	3.1	3.9	2.7	3.1	3.9	mA
			Full range	3.9			3.9			
$a_x$	Crosstalk attenuation	$V_{IC} = 0$ , $R_L = 2\text{ k}\Omega$	25°C	120			120			dB
$I_{OS}$	Short-circuit output current	$V_O = 0$	25°C	$V_{ID} = 1\text{ V}$	-30	-45	-30	-45	mA	
				$V_{ID} = -1\text{ V}$	30	48	30	48		

**TLE2072I operating characteristics at specified free-air temperature,  $V_{CC\pm} = \pm 15\text{ V}$**

PARAMETER	TEST CONDITIONS	$T_A$ †	TLE2072I			TLE2072AI			UNIT
			MIN	TYP	MAX	MIN	TYP	MAX	
SR+	Positive slew rate	$V_{O(PP)} = \pm 10\text{ V}$ , $A_{VD} = -1$ , $C_L = 100\text{ pF}$ , $R_L = 2\text{ k}\Omega$ , See Figure 1	25°C	28	40	28	40	$\text{V}/\mu\text{s}$	
			Full range	22			22		
SR-	Negative slew rate		25°C	30	45	30	45	$\text{V}/\mu\text{s}$	
			Full range	22			22		
$t_s$	Settling time	$A_{VD} = -1$ , 10-V step, $R_L = 1\text{ k}\Omega$ , $C_L = 100\text{ pF}$	25°C	To 10 mV	0.4		0.4		$\mu\text{s}$
				To 1 mV	1.5		1.5		
$V_n$	Equivalent input noise voltage		25°C	f = 10 Hz	28	55	28	55	$\text{nV}/\sqrt{\text{Hz}}$
				f = 10 kHz	11.6	17	11.6	17	
$V_{N(PP)}$	Peak-to-peak equivalent input noise voltage	$R_S = 20\ \Omega$ , See Figure 3	25°C	f = 0 Hz to 10 kHz	6		6		$\mu\text{V}$
				f = 0.1 Hz to 10 Hz	0.6		0.6		
$I_n$	Equivalent input noise current	$V_{IC} = 0$ , f = 10 kHz	25°C	2.8		2.8		$\text{fA}/\sqrt{\text{Hz}}$	
THD + N	Total harmonic distortion plus noise	$V_{O(PP)} = 20\text{ V}$ , f = 1 kHz, $R_S = 25\ \Omega$	25°C	0.008%		0.008%			
$B_1$	Unity-gain bandwidth	$V_I = 10\text{ mV}$ , $C_L = 25\text{ pF}$ , $R_L = 2\text{ k}\Omega$ , See Figure 2	25°C	8	10	8	10	MHz	
$B_{OM}$	Maximum output-swing bandwidth	$V_{O(PP)} = 20\text{ V}$ , $R_L = 2\text{ k}\Omega$ , $A_{VD} = -1$ , $C_L = 25\text{ pF}$	25°C	478	637	478	637	kHz	
$\phi_m$	Phase margin at unity gain	$V_I = 10\text{ mV}$ , $C_L = 25\text{ pF}$ , $R_L = 2\text{ k}\Omega$ , See Figure 2	25°C	57°		57°			

† Full range is -40°C to 85°C.

# TLE207x, TLE207xA EXCALIBUR LOW-NOISE HIGH-SPEED JFET-INPUT OPERATIONAL AMPLIFIERS

SLOS181B – FEBRUARY 1997 – REVISED APRIL 2004

**TLE2072M electrical characteristics at specified free-air temperature,  $V_{CC\pm} = \pm 5\text{ V}$  (unless otherwise noted)**

PARAMETER	TEST CONDITIONS	$T_A$ †	TLE2072M			TLE2072AM			UNIT	
			MIN	TYP	MAX	MIN	TYP	MAX		
$V_{IO}$ Input offset voltage	$V_{IC} = 0, V_O = 0,$ $R_S = 50\ \Omega,$	25°C	0.9	6	0.65	3.5	mV			
		Full range	10.5			8				
$\alpha_{VIO}$ Temperature coefficient of input offset voltage		Full range	2.3	25*	2.3	25*	$\mu\text{V}/^\circ\text{C}$			
$I_{IO}$ Input offset current	$V_{IC} = 0, V_O = 0,$ See Figure 4	25°C	5	100	5	100	pA			
		Full range	20			20				
$I_{IB}$ Input bias current		25°C	15	175	15	175	pA			
		Full range	60			60				
$V_{ICR}$ Common-mode input voltage range	$R_S = 50\ \Omega$	25°C	5 to -1	5 to -1.9	5 to -1	5 to -1.9	V			
		Full range	5 to -0.8		5 to -0.8					
$V_{OM+}$ Maximum positive peak output voltage swing	$I_O = -200\ \mu\text{A}$	25°C	3.8	4.1	3.8	4.1	V			
		Full range	3.6			3.6				
	$I_O = -2\ \text{mA}$	25°C	3.5	3.9	3.5	3.9				
		Full range	3.3			3.3				
	$I_O = -20\ \text{mA}$	25°C	1.5	2.3	1.5	2.3				
		Full range	1.4			1.4				
$V_{OM-}$ Maximum negative peak output voltage swing	$I_O = 200\ \mu\text{A}$	25°C	-3.8	-4.2	-3.8	-4.2	V			
		Full range	-3.6			-3.6				
	$I_O = 2\ \text{mA}$	25°C	-3.5	-4.1	-3.5	-4.1				
		Full range	-3.3			-3.3				
	$I_O = 20\ \text{mA}$	25°C	-1.5	-2.4	-1.5	-2.4				
		Full range	-1.4			-1.4				
$A_{VD}$ Large-signal differential voltage amplification	$V_O = \pm 2.3\ \text{V}$	$R_L = 600\ \Omega$	25°C	80	91	80	91	dB		
			Full range	78			78			
		$R_L = 2\ \text{k}\Omega$	25°C	90	100	90	100			
			Full range	88			88			
		$R_L = 10\ \text{k}\Omega$	25°C	95	106	95	106			
			Full range	93			93			
$r_i$ Input resistance	$V_{IC} = 0$	25°C	$10^{12}$			$10^{12}$			$\Omega$	
$c_i$ Input capacitance	$V_{IC} = 0,$ See Figure 5	Common mode	25°C	11			11			pF
		Differential	25°C	2.5			2.5			
$z_o$ Open-loop output impedance	$f = 1\ \text{MHz}$	25°C	80			80			$\Omega$	
CMRR Common-mode rejection ratio	$V_{IC} = V_{ICRmin},$ $V_O = 0, R_S = 50\ \Omega$	25°C	70	89	70	89	dB			
		Full range	68			68				

\*On products compliant to MIL-PRF-38535, Class B, this parameter is not production tested.

† Full range is  $-55^\circ\text{C}$  to  $125^\circ\text{C}$ .



**TLE207x, TLE207xA**  
**EXCALIBUR LOW-NOISE HIGH-SPEED**  
**JFET-INPUT OPERATIONAL AMPLIFIERS**

SLOS181B – FEBRUARY 1997 – REVISED APRIL 2004

**TLE2072M electrical characteristics at specified free-air temperature,  $V_{CC\pm} = \pm 5\text{ V}$  (unless otherwise noted) (continued)**

PARAMETER	TEST CONDITIONS	$T_A$ †	TLE2072M			TLE2072AM			UNIT	
			MIN	TYP	MAX	MIN	TYP	MAX		
$k_{SVR}$	Supply-voltage rejection ratio ( $\Delta V_{CC\pm} / \Delta V_{IO}$ )	$V_{CC\pm} = \pm 5\text{ V}$ to $\pm 15\text{ V}$ , $V_O = 0$ , $R_S = 50\ \Omega$	Full range			80			dB	
$I_{CC}$	Supply current (both channels)	$V_O = 0$ , No load	25°C			2.7 2.9 3.6			mA	
			Full range			3.6				
$a_x$	Crosstalk attenuation	$V_{IC} = 0$ , $R_L = 2\text{ k}\Omega$	25°C			120			dB	
$I_{OS}$	Short-circuit output current	$V_O = 0$	25°C	$V_{ID} = 1\text{ V}$			-35			mA
				$V_{ID} = -1\text{ V}$			45			

† Full range is  $-55^\circ\text{C}$  to  $125^\circ\text{C}$ .

**TLE2072M operating characteristics at specified free-air temperature,  $V_{CC\pm} = \pm 5\text{ V}$**

PARAMETER	TEST CONDITIONS	$T_A$ †	TLE2072M			TLE2072AM			UNIT
			MIN	TYP	MAX	MIN	TYP	MAX	
$SR+$	Positive slew rate	$V_{O(PP)} = \pm 2.3\text{ V}$ , $A_{VD} = -1$ , $R_L = 2\text{ k}\Omega$ , $C_L = 100\text{ pF}$ , See Figure 1	25°C			35			V/ $\mu\text{s}$
			Full range			18*			
$SR-$	Negative slew rate	$V_{O(PP)} = \pm 2.3\text{ V}$ , $A_{VD} = -1$ , $R_L = 2\text{ k}\Omega$ , $C_L = 100\text{ pF}$ , See Figure 1	25°C			38			V/ $\mu\text{s}$
			Full range			18*			
$t_s$	Settling time	$A_{VD} = -1$ , 2-V step, $R_L = 1\text{ k}\Omega$ , $C_L = 100\text{ pF}$	To 10 mV			0.25			$\mu\text{s}$
			To 1 mV			0.4			
$V_n$	Equivalent input noise voltage	$R_S = 20\ \Omega$ , See Figure 3	25°C			28 55*			nV/ $\sqrt{\text{Hz}}$
			f = 10 kHz			11.6 17*			
$V_{N(PP)}$	Peak-to-peak equivalent input noise voltage	$R_S = 20\ \Omega$ , See Figure 3	25°C			6			$\mu\text{V}$
			f = 0.1 Hz to 10 Hz			0.6			
$I_n$	Equivalent input noise current	$V_{IC} = 0$ , f = 10 kHz	25°C			2.8			fA/ $\sqrt{\text{Hz}}$
THD + N	Total harmonic distortion plus noise	$V_{O(PP)} = 5\text{ V}$ , f = 1 kHz, $R_S = 25\ \Omega$	25°C			0.013%			
$B_1$	Unity-gain bandwidth	$V_I = 10\text{ mV}$ , $C_L = 25\text{ pF}$ , $R_L = 2\text{ k}\Omega$ , See Figure 2	25°C			9.4			MHz
$B_{OM}$	Maximum output-swing bandwidth	$V_{O(PP)} = 4\text{ V}$ , $R_L = 2\text{ k}\Omega$ , $A_{VD} = -1$ , $C_L = 25\text{ pF}$	25°C			2.8			MHz
$\phi_m$	Phase margin at unity gain	$V_I = 10\text{ mV}$ , $C_L = 25\text{ pF}$ , $R_L = 2\text{ k}\Omega$ , See Figure 2	25°C			56°			

\*On products compliant to MIL-PRF-38535, Class B, this parameter is not production tested.

† Full range is  $-55^\circ\text{C}$  to  $125^\circ\text{C}$ .



# TLE207x, TLE207xA EXCALIBUR LOW-NOISE HIGH-SPEED JFET-INPUT OPERATIONAL AMPLIFIERS

SLOS181B – FEBRUARY 1997 – REVISED APRIL 2004

**TLE2072M electrical characteristics at specified free-air temperature,  $V_{CC\pm} = \pm 15$  V (unless otherwise noted)**

PARAMETER	TEST CONDITIONS	$T_A$ †	TLE2072M			TLE2072AM			UNIT	
			MIN	TYP	MAX	MIN	TYP	MAX		
$V_{IO}$ Input offset voltage	$V_{IC} = 0, V_O = 0, R_S = 50 \Omega$	25°C	1.1	6		0.7	3.5	mV		
		Full range			10.5		8			
$\alpha_{VIO}$ Temperature coefficient of input offset voltage		Full range	2.4	25*		2.4	25*	$\mu V/^\circ C$		
$I_{IO}$ Input offset current	$V_{IC} = 0, V_O = 0, \text{See Figure 4}$	25°C	6	100		6	100	pA		
		Full range			20		20	nA		
$I_{IB}$ Input bias current		25°C	20	175		20	175	pA		
		Full range			60		60	nA		
$V_{ICR}$ Common-mode input voltage range	$R_S = 50 \Omega$	25°C	15 to -11	15 to -11.9		15 to -11	15 to -11.9	V		
		Full range	15 to -10.8			15 to -10.8				
$V_{OM+}$ Maximum positive peak output voltage swing	$I_O = -200 \mu A$	25°C	13.8	14.1		13.8	14.1	V		
		Full range	13.6			13.6				
	$I_O = -2 \text{ mA}$	25°C	13.5	13.9		13.5	13.9			
		Full range	13.3			13.3				
$I_O = -20 \text{ mA}$	25°C	11.5	12.3		11.5	12.3				
	Full range	11.4			11.4					
$V_{OM-}$ Maximum negative peak output voltage swing	$I_O = 200 \mu A$	25°C	-13.8	-14.2		-13.8	-14.2	V		
		Full range	-13.6			-13.6				
	$I_O = 2 \text{ mA}$	25°C	-13.5	-14		-13.5	-14			
		Full range	-13.3			-13.3				
$I_O = 20 \text{ mA}$	25°C	-11.5	-12.4		-11.5	-12.4				
	Full range	-11.4			-11.4					
$A_{VD}$ Large-signal differential voltage amplification	$V_O = \pm 10 \text{ V}$	$R_L = 600 \Omega$	25°C	80	96		80	96	dB	
			Full range	78			78			
		$R_L = 2 \text{ k}\Omega$	25°C	90	109		90	109		
			Full range	89			89			
		$R_L = 10 \text{ k}\Omega$	25°C	95	118		95	118		
			Full range	93			93			
$r_i$ Input resistance	$V_{IC} = 0$	25°C	$10^{12}$			$10^{12}$			$\Omega$	
$c_i$ Input capacitance	$V_{IC} = 0, \text{See Figure 5}$	Common mode	25°C	7.5			7.5			pF
		Differential	25°C	2.5			2.5			
$z_o$ Open-loop output impedance	$f = 1 \text{ MHz}$	25°C	80			80			$\Omega$	
CMRR Common-mode rejection ratio	$V_{IC} = V_{ICRmin}, V_O = 0, R_S = 50 \Omega$	25°C	80	98		80	98	dB		
		Full range	78			78				
$k_{SVR}$ Supply-voltage rejection ratio ( $\Delta V_{CC\pm}/\Delta V_{IO}$ )	$V_{CC\pm} = \pm 5 \text{ V to } \pm 15 \text{ V}, V_O = 0, R_S = 50 \Omega$	25°C	82	99		82	99	dB		
		Full range	80			80				

\*On products compliant to MIL-PRF-38535, Class B, this parameter is not production tested.

† Full range is  $-55^\circ C$  to  $125^\circ C$ .



**TLE207x, TLE207xA**  
**EXCALIBUR LOW-NOISE HIGH-SPEED**  
**JFET-INPUT OPERATIONAL AMPLIFIERS**

SLOS181B – FEBRUARY 1997 – REVISED APRIL 2004

**TLE2072M electrical characteristics at specified free-air temperature,  $V_{CC\pm} = \pm 15\text{ V}$  (unless otherwise noted)**

PARAMETER	TEST CONDITIONS	$T_A$ †	TLE2072M			TLE2072AM			UNIT	
			MIN	TYP	MAX	MIN	TYP	MAX		
$I_{CC}$	Supply current (both channels)	$V_O = 0$ , No load	25°C	2.7	3.1	3.6	2.7	3.1	3.6	mA
			Full range	3.6			3.6			
$a_x$	Crosstalk attenuation	$V_{IC} = 0$ , $R_L = 2\text{ k}\Omega$	25°C	120			120			dB
$I_{OS}$	Short-circuit output current	$V_O = 0$	25°C	$V_{ID} = 1\text{ V}$	-30	-45	-30	-45	mA	
				$V_{ID} = -1\text{ V}$	30	48	30	48		

† Full range is  $-55^\circ\text{C}$  to  $125^\circ\text{C}$ .

**TLE2072M operating characteristics at specified free-air temperature,  $V_{CC\pm} = \pm 15\text{ V}$**

PARAMETER	TEST CONDITIONS	$T_A$ †	TLE2072M			TLE2072AM			UNIT
			MIN	TYP	MAX	MIN	TYP	MAX	
SR+	Positive slew rate	$V_{O(PP)} = 10\text{ V}$ , $A_{VD} = -1$ , $R_L = 2\text{ k}\Omega$ , $C_L = 100\text{ pF}$ , See Figure 1	25°C	28	40		28	40	$\text{V}/\mu\text{s}$
			Full range	20			20		
SR-	Negative slew rate	$V_{O(PP)} = 10\text{ V}$ , $A_{VD} = -1$ , $R_L = 2\text{ k}\Omega$ , $C_L = 100\text{ pF}$ , See Figure 1	25°C	30	45		30	45	$\text{V}/\mu\text{s}$
			Full range	20			20		
$t_s$	Settling time	$A_{VD} = -1$ , 10-V step, $R_L = 1\text{ k}\Omega$ , $C_L = 100\text{ pF}$	25°C	To 10 mV	0.4		0.4		$\mu\text{s}$
				To 1 mV	1.5		1.5		
$V_n$	Equivalent input noise voltage	$R_S = 20\ \Omega$ , See Figure 3	25°C	$f = 10\text{ Hz}$	28	55*	28	55*	$\text{nV}/\sqrt{\text{Hz}}$
				$f = 10\text{ kHz}$	11.6	17*	11.6	17*	
$V_{N(PP)}$	Peak-to-peak equivalent input noise voltage	$R_S = 20\ \Omega$ , See Figure 3	25°C	$f = 10\text{ Hz to } 10\text{ kHz}$	6		6		$\mu\text{V}$
				$f = 0.1\text{ Hz to } 10\text{ Hz}$	0.6		0.6		
$I_n$	Equivalent input noise current	$V_{IC} = 0$ , $f = 10\text{ kHz}$	25°C	2.8		2.8		$\text{fA}/\sqrt{\text{Hz}}$	
THD + N	Total harmonic distortion plus noise	$V_{O(PP)} = 20\text{ V}$ , $f = 1\text{ kHz}$ , $R_S = 25\ \Omega$ , $A_{VD} = 10$ , $R_L = 2\text{ k}\Omega$	25°C	0.008%		0.008%			
$B_1$	Unity-gain bandwidth	$V_I = 10\text{ mV}$ , $R_L = 2\text{ k}\Omega$ , $C_L = 25\text{ pF}$ , See Figure 2	25°C	8*	10	8*	10	MHz	
$B_{OM}$	Maximum output-swing bandwidth	$V_{O(PP)} = 20\text{ V}$ , $R_L = 2\text{ k}\Omega$ , $A_{VD} = -1$ , $C_L = 25\text{ pF}$	25°C	478*	637	478*	637	kHz	
$\phi_m$	Phase margin at unity gain	$V_I = 10\text{ mV}$ , $R_L = 2\text{ k}\Omega$ , $C_L = 25\text{ pF}$ , See Figure 2	25°C	57°		57°			

\*On products compliant to MIL-PRF-38535, Class B, this parameter is not production tested.

† Full range is  $-55^\circ\text{C}$  to  $125^\circ\text{C}$ .



# TLE207x, TLE207xA EXCALIBUR LOW-NOISE HIGH-SPEED JFET-INPUT OPERATIONAL AMPLIFIERS

SLOS181B – FEBRUARY 1997 – REVISED APRIL 2004

## TLE2072Y electrical characteristics at $V_{CC\pm} = \pm 15\text{ V}$ , $T_A = 25^\circ\text{C}$

PARAMETER	TEST CONDITIONS	TLE2072Y			UNIT
		MIN	TYP	MAX	
$V_{IO}$ Input offset voltage	$V_{IC} = 0$ , $V_O = 0$ , $R_S = 50\ \Omega$		1.1	6	mV
$I_{IO}$ Input offset current	$V_{IC} = 0$ , $V_O = 0$ , See Figure 4		6	100	pA
$I_{IB}$ Input bias current			20	175	pA
$V_{ICR}$ Common-mode input voltage range	$R_S = 50\ \Omega$	15 to -11	15 to 11.9		V
$V_{OM+}$ Maximum positive peak output voltage swing	$I_O = -200\ \mu\text{A}$	13.8	14.1		V
	$I_O = -2\ \text{mA}$	13.5	13.9		
	$I_O = -20\ \text{mA}$	11.5	12.3		
$V_{OM-}$ Maximum negative peak output voltage swing	$I_O = 200\ \mu\text{A}$	-13.8	-14.2		V
	$I_O = 2\ \text{mA}$	-13.5	-14		
	$I_O = 20\ \text{mA}$	-11.5	-12.4		
$A_{VD}$ Large-signal differential voltage amplification	$V_O = \pm 10\ \text{V}$	$R_L = 600\ \Omega$	80	96	dB
		$R_L = 2\ \text{k}\Omega$	90	109	
		$R_L = 10\ \text{k}\Omega$	95	118	
$r_i$ Input resistance	$V_{IC} = 0$		10 <sup>12</sup>		$\Omega$
$c_i$ Input capacitance	$V_{IC} = 0$ , See Figure 5	Common mode	7.5		pF
		Differential	2.5		
$z_o$ Open-loop output impedance	$f = 1\ \text{MHz}$		80		$\Omega$
CMRR Common-mode rejection ratio	$V_{IC} = V_{ICRmin}$ , $V_O = 0$ , $R_S = 50\ \Omega$	80	98		dB
$k_{SVR}$ Supply-voltage rejection ratio ( $\Delta V_{CC\pm}/\Delta V_{IO}$ )	$V_{CC\pm} = \pm 5\ \text{V}$ to $\pm 15\ \text{V}$ , $R_S = 50\ \Omega$ , $V_O = 0$	82	99		dB
$I_{CC}$ Supply current (both channels)	$V_O = 0$ , No load	2.7	3.1	3.9	mA
$I_{OS}$ Short-circuit output current	$V_O = 0$	$V_{ID} = 1\ \text{V}$	-30	-45	mA
		$V_{ID} = -1\ \text{V}$	30	48	



**TLE207x, TLE207xA**  
**EXCALIBUR LOW-NOISE HIGH-SPEED**  
**JFET-INPUT OPERATIONAL AMPLIFIERS**

SLOS181B – FEBRUARY 1997 – REVISED APRIL 2004

**TLE2074C electrical characteristics at specified free-air temperature,  $V_{CC\pm} = \pm 5\text{ V}$  (unless otherwise noted)**

PARAMETER	TEST CONDITIONS	$T_A$ †	TLE2074C			TLE2074AC			UNIT
			MIN	TYP	MAX	MIN	TYP	MAX	
$V_{IO}$ Input offset voltage	$V_{IC} = 0,$ $R_S = 50\ \Omega$	25°C	-1.6	5		-0.5	3	mV	
		Full range			7.1		5.1		
$\alpha_{VIO}$ Temperature coefficient of input offset voltage		Full range	10.1	30		10.1	30	$\mu\text{V}/^\circ\text{C}$	
$I_{IO}$ Input offset current	$V_{IC} = 0,$ $V_O = 0,$ See Figure 4	25°C	15	100		15	100	pA	
		Full range			1400		1400		
$I_{IB}$ Input bias current		25°C	20	175		20	175	pA	
		Full range			5000		5000		
$V_{ICR}$ Common-mode input voltage range	$R_S = 50\ \Omega$	25°C	5 to -1	5 to -1.9		5 to -1	5 to -1.9	V	
		Full range	5 to -0.9			5 to -0.9			
$V_{OM+}$ Maximum positive peak output voltage swing	$I_O = -200\ \mu\text{A}$	25°C	3.8	4.1		3.8	4.1	V	
		Full range	3.7			3.7			
	$I_O = -2\ \text{mA}$	25°C	3.5	3.9		3.5	3.9		
		Full range	3.4			3.4			
	$I_O = -20\ \text{mA}$	25°C	1.5	2.3		1.5	2.3		
		Full range	1.5			1.5			
$V_{OM-}$ Maximum negative peak output voltage swing	$I_O = 200\ \mu\text{A}$	25°C	-3.8	-4.2		-3.8	-4.2	V	
		Full range	-3.7			-3.7			
	$I_O = 2\ \text{mA}$	25°C	-3.5	-4.1		-3.5	-4.1		
		Full range	-3.4			-3.4			
	$I_O = 20\ \text{mA}$	25°C	-1.5	-2.4		-1.5	-2.4		
		Full range	-1.5			-1.5			
$A_{VD}$ Large-signal differential voltage amplification	$V_O = \pm 2.3\ \text{V}$	$R_L = 600\ \Omega$	25°C	80	91		80	91	dB
			Full range	79			79		
		$R_L = 2\ \text{k}\Omega$	25°C	90	100		90	100	
			Full range	89			89		
		$R_L = 10\ \text{k}\Omega$	25°C	95	106		95	106	
			Full range	94			94		
$r_i$ Input resistance	$V_{IC} = 0$	25°C	$10^{12}$			$10^{12}$			$\Omega$
$c_i$ Input capacitance	Common mode	25°C	11			11			pF
	Differential	$V_{IC} = 0,$ See Figure 5	25°C	2.5			2.5		
$z_o$ Open-loop output impedance	$f = 1\ \text{MHz}$	25°C	80			80			$\Omega$
CMRR Common-mode rejection ratio	$V_{IC} = V_{ICRmin},$ $V_O = 0,$ $R_S = 50\ \Omega$	25°C	70	89		70	89	dB	
		Full range	68			68			
$k_{SVR}$ Supply-voltage rejection ratio ( $\Delta V_{CC\pm}/\Delta V_{IO}$ )	$V_{CC\pm} = \pm 5\ \text{V}$ to $\pm 15\ \text{V},$ $V_O = 0,$ $R_S = 50\ \Omega$	25°C	82	99		82	99	dB	
		Full range	80			80			

† Full range is 0°C to 70°C.

# TLE207x, TLE207xA EXCALIBUR LOW-NOISE HIGH-SPEED JFET-INPUT OPERATIONAL AMPLIFIERS

SLOS181B – FEBRUARY 1997 – REVISED APRIL 2004

**TLE2074C electrical characteristics at specified free-air temperature,  $V_{CC\pm} = \pm 5\text{ V}$  (unless otherwise noted) (continued)**

PARAMETER	TEST CONDITIONS	$T_A$ †	TLE2074C			TLE2074AC			UNIT
			MIN	TYP	MAX	MIN	TYP	MAX	
$I_{CC}$	Supply current (four amplifiers) $V_O = 0$ , No load	25°C	5.2	6.3	7.5	5.2	6.3	7.5	mA
		Full range	7.5			7.5			
	Crosstalk attenuation	$V_{IC} = 0$ , $R_L = 2\text{ k}\Omega$	120			120			dB
$I_{OS}$	Short-circuit output current $V_O = 0$	$V_{ID} = 1\text{ V}$	-35			-35			mA
		$V_{ID} = -1\text{ V}$	45			45			

† Full range is 0°C to 70°C.

**TLE2074C operating characteristics at specified free-air temperature,  $V_{CC\pm} = \pm 5\text{ V}$**

PARAMETER	TEST CONDITIONS	$T_A$ †	TLE2074C			TLE2074AC			UNIT
			MIN	TYP	MAX	MIN	TYP	MAX	
SR+	Positive slew rate	25°C	35			35			V/ $\mu$ s
		Full range	22			22			
SR-	Negative slew rate	25°C	38			38			V/ $\mu$ s
		Full range	22			22			
$t_s$	Settling time	25°C		To 10 mV	0.25		0.25		$\mu$ s
				To 1 mV	0.4		0.4		
$V_n$	Equivalent input noise voltage	25°C		f = 10 Hz	28	55	28	55	nV/ $\sqrt{\text{Hz}}$
				f = 10 kHz	11.6	17	11.6	17	
$V_{N(PP)}$	Peak-to-peak equivalent input noise voltage	25°C		f = 10 Hz to 10 kHz	6		6		$\mu$ V
				f = 0.1 Hz to 10 Hz	0.6		0.6		
$I_n$	Equivalent input noise current	25°C		$V_{IC} = 0$ , f = 10 kHz	2.8		2.8		fA/ $\sqrt{\text{Hz}}$
THD + N	Total harmonic distortion plus noise	25°C		$V_{O(PP)} = 5\text{ V}$ , f = 1 kHz, $R_S = 25\ \Omega$ , $A_{VD} = 10$ , $R_L = 2\text{ k}\Omega$	0.013%		0.013%		
$B_1$	Unity-gain bandwidth	25°C		$V_I = 10\text{ mV}$ , $C_L = 25\text{ pF}$ , $R_L = 2\text{ k}\Omega$ , See Figure 2	9.4		9.4		MHz
$B_{OM}$	Maximum output-swing bandwidth	25°C		$V_{O(PP)} = 4\text{ V}$ , $R_L = 2\text{ k}\Omega$ , $A_{VD} = -1$ , $C_L = 25\text{ pF}$	2.8		2.8		MHz
$\phi_m$	Phase margin at unity gain	25°C		$V_I = 10\text{ mV}$ , $R_L = 2\text{ k}\Omega$ , $C_L = 25\text{ pF}$ , See Figure 2	56°		56°		

† Full range is 0°C to 70°C.



**TLE207x, TLE207xA**  
**EXCALIBUR LOW-NOISE HIGH-SPEED**  
**JFET-INPUT OPERATIONAL AMPLIFIERS**

SLOS181B – FEBRUARY 1997 – REVISED APRIL 2004

**TLE2074C electrical characteristics at specified free-air temperature,  $V_{CC\pm} = \pm 15\text{ V}$  (unless otherwise noted)**

PARAMETER	TEST CONDITIONS	$T_A$ †	TLE2074C			TLE2074AC			UNIT
			MIN	TYP	MAX	MIN	TYP	MAX	
$V_{IO}$ Input offset voltage	$V_{IC} = 0, V_O = 0,$ $R_S = 50\ \Omega$	25°C	-1.6	5		-0.5	3	mV	
		Full range			7.1		5.1		
$\alpha_{VIO}$ Temperature coefficient of input offset voltage		Full range	10.1	30		10.1	30	$\mu\text{V}/^\circ\text{C}$	
$I_{IO}$ Input offset current	$V_{IC} = 0, V_O = 0,$ See Figure 4	25°C	15	100		15	100	pA	
		Full range			1400		1400		
$I_{IB}$ Input bias current		25°C	25	175		25	175	pA	
		Full range			5000		5000		
$V_{ICR}$ Common-mode input voltage range	$R_S = 50\ \Omega$	25°C	15 to -11	15 to -11.9		15 to -11	15 to -11.9	V	
		Full range	15 to -10.9			15 to -10.9			
$V_{OM+}$ Maximum positive peak output voltage swing	$I_O = -200\ \mu\text{A}$	25°C	13.8	14.1		13.8	14.1	V	
		Full range	13.7			13.7			
	$I_O = -2\ \text{mA}$	25°C	13.5	13.9		13.5	13.9		
		Full range	13.4			13.4			
	$I_O = -20\ \text{mA}$	25°C	11.5	12.3		11.5	12.3		
		Full range	11.5			11.5			
$V_{OM-}$ Maximum negative peak output voltage swing	$I_O = 200\ \mu\text{A}$	25°C	-13.8	-14.2		-13.8	-14.2	V	
		Full range	-13.7			-13.7			
	$I_O = 2\ \text{mA}$	25°C	-13.7	-14		-13.7	-14		
		Full range	-13.6			-13.6			
	$I_O = 20\ \text{mA}$	25°C	-11.5	-12.4		-11.5	-12.4		
		Full range	-11.5			-11.5			
$A_{VD}$ Large-signal differential voltage amplification	$V_O = \pm 10\ \text{V}$	$R_L = 600\ \Omega$	25°C	80	96		80	96	dB
			Full range	79			79		
		$R_L = 2\ \text{k}\Omega$	25°C	90	109		90	109	
			Full range	89			89		
		$R_L = 10\ \text{k}\Omega$	25°C	95	118		95	118	
			Full range	94			94		
$r_i$ Input resistance	$V_{IC} = 0$	25°C	$10^{12}$		$10^{12}$		$\Omega$		
$c_i$ Input capacitance	Common mode	$V_{IC} = 0,$ See Figure 5	25°C	7.5		7.5		pF	
	Differential		25°C	2.5		2.5			
$z_o$ Open-loop output impedance	$f = 1\ \text{MHz}$	25°C	80		80		$\Omega$		
CMRR Common-mode rejection ratio	$V_{IC} = V_{ICR\text{min}},$ $V_O = 0,$ $R_S = 50\ \Omega$	25°C	80	98		80	98	dB	
		Full range	79			79			
$k_{SVR}$ Supply-voltage rejection ratio ( $\Delta V_{CC\pm}/\Delta V_{IO}$ )	$V_{CC\pm} = \pm 5\ \text{V}$ to $\pm 15\ \text{V},$ $V_O = 0,$ $R_S = 50\ \Omega$	25°C	82	99		82	99	dB	
		Full range	81			81			

† Full range is 0°C to 70°C.



**TLE207x, TLE207xA**  
**EXCALIBUR LOW-NOISE HIGH-SPEED**  
**JFET-INPUT OPERATIONAL AMPLIFIERS**

SLOS181B – FEBRUARY 1997 – REVISED APRIL 2004

**TLE2074C electrical characteristics at specified free-air temperature,  $V_{CC\pm} = \pm 15$  V (unless otherwise noted) (continued)**

PARAMETER	TEST CONDITIONS	$T_A$ †	TLE2074C			TLE2074AC			UNIT	
			MIN	TYP	MAX	MIN	TYP	MAX		
$I_{CC}$	Supply current (four amplifiers)	$V_O = 0$ , No load	25°C	5.2	6.5	7.5	5.2	6.5	7.5	mA
			Full range	7.5			7.5			
	Crosstalk attenuation	$V_{IC} = 0$ , $R_L = 2$ k $\Omega$	25°C	120			120			dB
$I_{OS}$	Short-circuit output current	$V_O = 0$	25°C	$V_{ID} = 1$ V	-30	-45	-30	-45	mA	
				$V_{ID} = -1$ V	30	48	30	48		

† Full range is 0°C to 70°C.

**TLE2074C operating characteristics at specified free-air temperature,  $V_{CC\pm} = \pm 15$  V**

PARAMETER	TEST CONDITIONS	$T_A$ †	TLE2074C			TLE2074AC			UNIT
			MIN	TYP	MAX	MIN	TYP	MAX	
SR+	Positive slew rate	$V_{O(PP)} = 10$ V, $A_{VD} = -1$ , $R_L = 2$ k $\Omega$ , $C_L = 100$ pF, See Figure 1	25°C	25	40	25	40	V/ $\mu$ s	
			Full range	22			22		
SR-	Negative slew rate		25°C	30	45	30	45	V/ $\mu$ s	
			Full range	25			25		
$t_s$	Settling time	$A_{VD} = -1$ , 10-V step, $R_L = 1$ k $\Omega$ , $C_L = 100$ pF	25°C	To 10 mV	0.4		0.4		$\mu$ s
				To 1 mV	1.5		1.5		
$V_n$	Equivalent input noise voltage		25°C	f = 10 Hz	28	55	28	55	nV/ $\sqrt{Hz}$
				f = 10 kHz	11.6	17	11.6	17	
$V_{N(PP)}$	Peak-to-peak equivalent input noise voltage	$R_S = 20$ $\Omega$ , See Figure 3	25°C	f = 10 Hz to 10 kHz	6		6		$\mu$ V
				f = 0.1 Hz to 10 Hz	0.6		0.6		
$I_n$	Equivalent input noise current	$V_{IC} = 0$ , f = 10 kHz	25°C	2.8		2.8		fA/ $\sqrt{Hz}$	
THD + N	Total harmonic distortion plus noise	$V_{O(PP)} = 20$ V, $A_{VD} = 10$ , f = 1 kHz, $R_L = 2$ k $\Omega$ , $R_S = 25$ $\Omega$	25°C	0.008%		0.008%			
$B_1$	Unity-gain bandwidth	$V_I = 10$ mV, $R_L = 2$ k $\Omega$ , $C_L = 25$ pF, See Figure 2	25°C	8	10	8	10	MHz	
$B_{OM}$	Maximum output-swing bandwidth	$V_{O(PP)} = 20$ V, $A_{VD} = -1$ , $R_L = 2$ k $\Omega$ , $C_L = 25$ pF	25°C	478	637	478	637	kHz	
$\phi_m$	Phase margin at unity gain	$V_I = 10$ mV, $R_L = 2$ k $\Omega$ , $C_L = 25$ pF, See Figure 2	25°C	57°		57°			

† Full range is 0°C to 70°C.



**TLE207x, TLE207xA**  
**EXCALIBUR LOW-NOISE HIGH-SPEED**  
**JFET-INPUT OPERATIONAL AMPLIFIERS**

SLOS181B – FEBRUARY 1997 – REVISED APRIL 2004

**TLE2074I electrical characteristics at specified free-air temperature,  $V_{CC\pm} = \pm 5\text{ V}$  (unless otherwise noted)**

PARAMETER	TEST CONDITIONS	$T_A$ †	TLE2074I			TLE2074AI			UNIT	
			MIN	TYP	MAX	MIN	TYP	MAX		
$V_{IO}$ Input offset voltage	$V_{IC} = 0, V_O = 0, R_S = 50\ \Omega$	25°C	-1.6	5		-0.5	3	mV		
		Full range			9		7			
$\alpha_{VIO}$ Temperature coefficient of input offset voltage		Full range	10.1	30		10.1	30	$\mu\text{V}/^\circ\text{C}$		
$I_{IO}$ Input offset current	$V_{IC} = 0, V_O = 0, \text{See Figure 4}$	25°C	15	100		15	100	pA		
		Full range		5			5	nA		
$I_{IB}$ Input bias current		25°C	20	175		20	175	pA		
		Full range		10			10	nA		
$V_{ICR}$ Common-mode input voltage range	$R_S = 50\ \Omega$	25°C	5 to -1	5 to -1.9		5 to -1	5 to -1.9	V		
		Full range	5 to -0.8			5 to -0.8				
$V_{OM+}$ Maximum positive peak output voltage swing	$I_O = -200\ \mu\text{A}$	25°C	3.8	4.1		3.8	4.1	V		
		Full range	3.7			3.7				
	$I_O = -2\ \text{mA}$	25°C	3.5	3.9		3.5	3.9			
		Full range	3.4			3.4				
$I_O = -20\ \text{mA}$	25°C	1.5	2.3		1.5	2.3				
	Full range	1.5			1.5					
$V_{OM-}$ Maximum negative peak output voltage swing	$I_O = 200\ \mu\text{A}$	25°C	-3.8	-4.2		-3.8	-4.2	V		
		Full range	-3.7			-3.7				
	$I_O = 2\ \text{mA}$	25°C	-3.5	-4.1		-3.5	-4.1			
		Full range	-3.4			-3.4				
$I_O = 20\ \text{mA}$	25°C	-1.5	-2.4		-1.5	-2.4				
	Full range	-1.5			-1.5					
$A_{VD}$ Large-signal differential voltage amplification	$V_O = \pm 2.3\ \text{V}$	$R_L = 600\ \Omega$	25°C	80	91		80	91	dB	
			Full range	79			79			
		$R_L = 2\ \text{k}\Omega$	25°C	90	100		90	100		
			Full range	89			89			
		$R_L = 10\ \text{k}\Omega$	25°C	95	106		95	106		
			Full range	94			94			
$r_i$ Input resistance	$V_{IC} = 0$	25°C	$10^{12}$			$10^{12}$			$\Omega$	
$c_i$ Input capacitance	Common mode	$V_{IC} = 0, \text{See Figure 5}$	25°C	11			11			pF
	Differential		25°C	2.5			2.5			
$z_o$ Open-loop output impedance	$f = 1\ \text{MHz}$	25°C	80			80			$\Omega$	
CMRR Common-mode rejection ratio	$V_{IC} = V_{ICRmin}, V_O = 0, R_S = 50\ \Omega$	25°C	70	89		70	89	dB		
		Full range	68			68				
$k_{SVR}$ Supply-voltage rejection ratio ( $\Delta V_{CC\pm}/\Delta V_{IO}$ )	$V_{CC\pm} = \pm 5\ \text{V to } \pm 15\ \text{V}, V_O = 0, R_S = 50\ \Omega$	25°C	82	99		82	99	dB		
		Full range	80			80				

† Full range is  $-40^\circ\text{C}$  to  $85^\circ\text{C}$ .

# TLE207x, TLE207xA EXCALIBUR LOW-NOISE HIGH-SPEED JFET-INPUT OPERATIONAL AMPLIFIERS

SLOS181B – FEBRUARY 1997 – REVISED APRIL 2004

**TLE2074I electrical characteristics at specified free-air temperature,  $V_{CC\pm} = \pm 5\text{ V}$  (unless otherwise noted) (continued)**

PARAMETER	TEST CONDITIONS	$T_A$ †	TLE2074I			TLE2074AI			UNIT	
			MIN	TYP	MAX	MIN	TYP	MAX		
$I_{CC}$	Supply current (four amplifiers)	$V_O = 0$ , No load	25°C	5.2	6.3	7.5	5.2	6.3	7.5	mA
			Full range	7.5			7.5			
	Crosstalk attenuation	$V_{IC} = 0$ , $R_L = 2\text{ k}\Omega$	25°C	120			120			dB
$I_{OS}$	Short-circuit output current	$V_O = 0$	25°C	$V_{ID} = 1\text{ V}$			-35			mA
				$V_{ID} = -1\text{ V}$			45			

† Full range is  $-40^\circ\text{C}$  to  $85^\circ\text{C}$ .

**TLE2074I operating characteristics at specified free-air temperature,  $V_{CC\pm} = \pm 5\text{ V}$**

PARAMETER	TEST CONDITIONS	$T_A$ †	TLE2074I			TLE2074AI			UNIT	
			MIN	TYP	MAX	MIN	TYP	MAX		
SR+	Positive slew rate	$V_O(PP) = \pm 2.3\text{ V}$ , $A_{VD} = -1$ , $C_L = 100\text{ pF}$ , $R_L = 2\text{ k}\Omega$ , See Figure 1	25°C	35			35			$\text{V}/\mu\text{s}$
			Full range	20			20			
SR-	Negative slew rate		25°C	38			38			$\text{V}/\mu\text{s}$
			Full range	20			20			
$t_s$	Settling time	$A_{VD} = -1$ , 2-V step, $R_L = 1\text{ k}\Omega$ , $C_L = 100\text{ pF}$	25°C	To 10 mV			0.25			$\mu\text{s}$
				To 1 mV			0.4			
$V_n$	Equivalent input noise voltage		25°C	f = 10 Hz		28		55		$\text{nV}/\sqrt{\text{Hz}}$
				f = 10 kHz		11.6		17		
$V_N(PP)$	Peak-to-peak equivalent input noise voltage	$R_S = 20\ \Omega$ , See Figure 3	25°C	f = 10 Hz to 10 kHz		6		6		$\mu\text{V}$
				f = 0.1 Hz to 10 Hz		0.6		0.6		
$I_n$	Equivalent input noise current	$V_{IC} = 0$ , f = 10 kHz	25°C	2.8		2.8		$\text{fA}/\sqrt{\text{Hz}}$		
THD + N	Total harmonic distortion plus noise	$V_O(PP) = 5\text{ V}$ , f = 1 kHz, $R_S = 25\ \Omega$	25°C	0.013%		0.013%				
$B_1$	Unity-gain bandwidth	$V_I = 10\text{ mV}$ , $C_L = 25\text{ pF}$ , $R_L = 2\text{ k}\Omega$ , See Figure 2	25°C	9.4		9.4		MHz		
$B_{OM}$	Maximum output-swing bandwidth	$V_O(PP) = 4\text{ V}$ , $R_L = 2\text{ k}\Omega$ , $A_{VD} = -1$ , $C_L = 25\text{ pF}$	25°C	2.8		2.8		MHz		
$\phi_m$	Phase margin at unity gain	$V_I = 10\text{ mV}$ , $C_L = 25\text{ pF}$ , $R_L = 2\text{ k}\Omega$ , See Figure 2	25°C	56°		56°				

† Full range is  $-40^\circ\text{C}$  to  $85^\circ\text{C}$ .



**TLE207x, TLE207xA**  
**EXCALIBUR LOW-NOISE HIGH-SPEED**  
**JFET-INPUT OPERATIONAL AMPLIFIERS**

SLOS181B – FEBRUARY 1997 – REVISED APRIL 2004

**TLE2074I electrical characteristics at specified free-air temperature,  $V_{CC\pm} = \pm 15$  V (unless otherwise noted)**

PARAMETER	TEST CONDITIONS	$T_A$ †	TLE2074I			TLE2074AI			UNIT	
			MIN	TYP	MAX	MIN	TYP	MAX		
$V_{IO}$ Input offset voltage	$V_{IC} = 0, V_O = 0,$ $R_S = 50 \Omega$	25°C	-1.6	5		-0.5	3	mV		
		Full range			9		7			
$\alpha_{VIO}$ Temperature coefficient of input offset voltage		Full range	10.1	30		10.1	30	$\mu\text{V}/^\circ\text{C}$		
$I_{IO}$ Input offset current	$V_{IC} = 0, V_O = 0,$ See Figure 4	25°C	15	100		15	100	pA		
		Full range		5		5		nA		
$I_{IB}$ Input bias current		25°C	25	175		25	175	pA		
		Full range		10		10		nA		
$V_{ICR}$ Common-mode input voltage range	$R_S = 50 \Omega$	25°C	15 to -11	15 to -11.9		15 to -11	15 to -11.9	V		
		Full range	15 to -10.8			15 to -10.8				
$V_{OM+}$ Maximum positive peak output voltage swing	$I_O = -200 \mu\text{A}$	25°C	13.8	14.1		13.8	14.1	V		
		Full range	13.7			13.7				
	$I_O = -2 \text{ mA}$	25°C	13.5	13.9		13.5	13.9			
		Full range	13.4			13.4				
	$I_O = -20 \text{ mA}$	25°C	11.5	12.3		11.5	12.3			
		Full range	11.5			11.5				
$V_{OM-}$ Maximum negative peak output voltage swing	$I_O = 200 \mu\text{A}$	25°C	-13.8	-14.2		-13.8	-14.2	V		
		Full range	-13.7			-13.7				
	$I_O = 2 \text{ mA}$	25°C	-13.5	-14		-13.5	-14			
		Full range	-13.4			-13.4				
	$I_O = 20 \text{ mA}$	25°C	-11.5	-12.4		-11.5	-12.4			
		Full range	-11.5			-11.5				
$A_{VD}$ Large-signal differential voltage amplification	$V_O = \pm 10 \text{ V}$	$R_L = 600 \Omega$	25°C	80	96		80	96	dB	
			Full range	79			79			
		$R_L = 2 \text{ k}\Omega$	25°C	90	109		90	109		
			Full range	89			89			
		$R_L = 10 \text{ k}\Omega$	25°C	95	118		95	118		
			Full range	94			94			
$r_i$ Input resistance	$V_{IC} = 0$	25°C	$10^{12}$			$10^{12}$			$\Omega$	
$c_i$ Input capacitance	Common mode	$V_{IC} = 0,$ See Figure 5	25°C	7.5			7.5			pF
	Differential		25°C	2.5			2.5			
$z_o$ Open-loop output impedance	$f = 1 \text{ MHz}$	25°C	80			80			$\Omega$	
CMRR Common-mode rejection ratio	$V_{IC} = V_{ICRmin},$ $V_O = 0, R_S = 50 \Omega$	25°C	80	98		80	98	dB		
		Full range	79			79				
$k_{SVR}$ Supply-voltage rejection ratio ( $\Delta V_{CC\pm}/\Delta V_{IO}$ )	$V_{CC\pm} = \pm 5 \text{ V to } \pm 15 \text{ V},$ $V_O = 0, R_S = 50 \Omega$	25°C	82	99		82	99	dB		
		Full range	80			80				

† Full range is  $-40^\circ\text{C}$  to  $85^\circ\text{C}$ .



# TLE207x, TLE207xA EXCALIBUR LOW-NOISE HIGH-SPEED JFET-INPUT OPERATIONAL AMPLIFIERS

SLOS181B – FEBRUARY 1997 – REVISED APRIL 2004

**TLE2074I electrical characteristics at specified free-air temperature,  $V_{CC\pm} = \pm 15$  V (unless otherwise noted) (continued)**

PARAMETER	TEST CONDITIONS	T <sub>A</sub> †	TLE2074I			TLE2074AI			UNIT	
			MIN	TYP	MAX	MIN	TYP	MAX		
I <sub>CC</sub>	Supply current (four amplifiers)	V <sub>O</sub> = 0, No load	25°C	5.2	6.5	7.5	5.2	6.5	7.5	mA
			Full range	7.5			7.5			
	Crosstalk attenuation	V <sub>IC</sub> = 0, R <sub>L</sub> = 2 kΩ	25°C	120			120			dB
I <sub>OS</sub>	Short-circuit output current	V <sub>O</sub> = 0	25°C	V <sub>ID</sub> = 1 V	-30	-45	-30	-45	mA	
				V <sub>ID</sub> = -1 V	30	48	30	48		

† Full range is -40°C to 85°C.

**TLE2074I operating characteristics at specified free-air temperature,  $V_{CC\pm} = \pm 15$  V**

PARAMETER	TEST CONDITIONS	T <sub>A</sub> †	TLE2074I			TLE2074AI			UNIT
			MIN	TYP	MAX	MIN	TYP	MAX	
SR+	Positive slew rate	V <sub>O(PP)</sub> = ±10 V, A <sub>VD</sub> = -1, C <sub>L</sub> = 100 pF, R <sub>L</sub> = 2 kΩ, See Figure 1	25°C	25	40		25	40	V/μs
			Full range	19			19		
SR-	Negative slew rate	V <sub>O(PP)</sub> = ±10 V, A <sub>VD</sub> = -1, C <sub>L</sub> = 100 pF, R <sub>L</sub> = 2 kΩ, See Figure 1	25°C	30	45		30	45	V/μs
			Full range	22			22		
t <sub>s</sub>	Settling time	A <sub>VD</sub> = -1, 10-V step, R <sub>L</sub> = 1 kΩ, C <sub>L</sub> = 100 pF	25°C	To 10 mV	0.4		0.4		μs
				To 1 mV	1.5		1.5		
V <sub>n</sub>	Equivalent input noise voltage	R <sub>S</sub> = 20 Ω, See Figure 3	25°C	f = 10 Hz	28	55	28	55	nV/√Hz
				f = 10 kHz	11.6	17	11.6	17	
V <sub>N(PP)</sub>	Peak-to-peak equivalent input noise voltage	R <sub>S</sub> = 20 Ω, See Figure 3	25°C	f = 10 Hz to 10 kHz	6		6		μV
				f = 0.1 Hz to 10 Hz	0.6		0.6		
I <sub>n</sub>	Equivalent input noise current	V <sub>IC</sub> = 0, f = 10 kHz	25°C	2.8			2.8		fA/√Hz
THD + N	Total harmonic distortion plus noise	V <sub>O(PP)</sub> = 20 V, A <sub>VD</sub> = 10, f = 1 kHz, R <sub>S</sub> = 25 Ω	25°C	0.008%			0.008%		
B <sub>1</sub>	Unity-gain bandwidth	V <sub>I</sub> = 10 mV, C <sub>L</sub> = 25 pF, R <sub>L</sub> = 2 kΩ, See Figure 2	25°C	8	10		8	10	MHz
B <sub>OM</sub>	Maximum output-swing bandwidth	V <sub>O(PP)</sub> = 20 V, A <sub>VD</sub> = -1, R <sub>L</sub> = 2 kΩ, C <sub>L</sub> = 25 pF	25°C	478	637		478	637	kHz
φ <sub>m</sub>	Phase margin at unity gain	V <sub>I</sub> = 10 mV, C <sub>L</sub> = 25 pF, R <sub>L</sub> = 2 kΩ, See Figure 2	25°C	57°			57°		

† Full range is -40°C to 85°C.





**TLE207x, TLE207xA**  
**EXCALIBUR LOW-NOISE HIGH-SPEED**  
**JFET-INPUT OPERATIONAL AMPLIFIERS**

SLOS181B – FEBRUARY 1997 – REVISED APRIL 2004

**TLE2074M electrical characteristics at specified free-air temperature,  $V_{CC\pm} = \pm 5\text{ V}$  (unless otherwise noted)**

PARAMETER	TEST CONDITIONS	$T_A$ †	TLE2074M			TLE2074AM			UNIT	
			MIN	TYP	MAX	MIN	TYP	MAX		
$V_{IO}$ Input offset voltage	$V_{IC} = 0, V_O = 0,$ $R_S = 50\Omega$	25°C	-1.6	5		-0.5	3	mV		
		Full range			10.5		8.5			
$\alpha_{VIO}$ Temperature coefficient of input offset voltage		Full range	10.1	30‡		10.1	30‡	$\mu\text{V}/^\circ\text{C}$		
$I_{IO}$ Input offset current	$V_{IC} = 0, V_O = 0,$ See Figure 4	25°C	15	100		15	100	pA		
		Full range			20		20	nA		
$I_{IB}$ Input bias current		25°C	20	175		20	175	pA		
		Full range			60		60	nA		
$V_{ICR}$ Common-mode input voltage range	$R_S = 50\Omega$	25°C	5 to -1	5 to -1.9		5 to -1	5 to -1.9	V		
		Full range	5 to -0.8			5 to -0.8				
$V_{OM+}$ Maximum positive peak output voltage swing	$I_O = -200\mu\text{A}$	25°C	3.8	4.1		3.8	4.1	V		
		Full range	3.6			3.6				
	$I_O = -2\text{ mA}$	25°C	3.5	3.9		3.5	3.9			
		Full range	3.3			3.3				
	$I_O = -20\text{ mA}$	25°C	1.5	2.3		1.5	2.3			
		Full range	1.4			1.4				
$V_{OM-}$ Maximum negative peak output voltage swing	$I_O = 200\mu\text{A}$	25°C	-3.8	-4.2		-3.8	-4.2	V		
		Full range	-3.6			-3.6				
	$I_O = 2\text{ mA}$	25°C	-3.5	-4.1		-3.5	-4.1			
		Full range	-3.3			-3.3				
	$I_O = 20\text{ mA}$	25°C	-1.5	-2.4		-1.5	-2.4			
		Full range	-1.4			-1.4				
$A_{VD}$ Large-signal differential voltage amplification	$V_O = \pm 2.3\text{ V}$	$R_L = 600\Omega$	25°C	80	91		80	91	dB	
			Full range	78			78			
		$R_L = 2\text{ k}\Omega$	25°C	90	100		90	100		
			Full range	88			88			
		$R_L = 10\text{ k}\Omega$	25°C	95	106		95	106		
			Full range	93			93			
$r_i$ Input resistance	$V_{IC} = 0$	25°C	$10^{12}$			$10^{12}$			$\Omega$	
$c_i$ Input capacitance	Common mode	$V_{IC} = 0,$ See Figure 5	25°C	11			11			pF
	Differential		25°C	2.5			2.5			
$z_o$ Open-loop output impedance	$f = 1\text{ MHz}$	25°C	80			80			$\Omega$	
CMRR Common-mode rejection ratio	$V_{IC} = V_{ICRmin},$ $V_O = 0, R_S = 50\Omega$	25°C	70	89		70	89	dB		
		Full range	68			68				
$k_{SVR}$ Supply-voltage rejection ratio ( $\Delta V_{CC\pm} / \Delta V_{IO}$ )	$V_{CC\pm} = \pm 5\text{ V to } \pm 15\text{ V},$ $V_O = 0, R_S = 50\Omega$	25°C	82	99		82	99	dB		
		Full range	80			80				

† Full range is  $-55^\circ\text{C}$  to  $125^\circ\text{C}$ .

‡ On products compliant to MIL-PRF-38535, Class B, this parameter is not production tested.



# TLE207x, TLE207xA EXCALIBUR LOW-NOISE HIGH-SPEED JFET-INPUT OPERATIONAL AMPLIFIERS

SLOS181B – FEBRUARY 1997 – REVISED APRIL 2004

**TLE2074M electrical characteristics at specified free-air temperature,  $V_{CC\pm} = \pm 5$  V (unless otherwise noted) (continued)**

PARAMETER	TEST CONDITIONS	$T_A$ †	TLE2074M			TLE2074AM			UNIT
			MIN	TYP	MAX	MIN	TYP	MAX	
$I_{CC}$ Supply current (four amplifiers)	$V_O = 0$ , No load	25°C	5.2	6.3	7.5	5.2	6.3	7.5	mA
		Full range	7.5			7.5			
Crosstalk attenuation	$V_{IC} = 0$ , $R_L = 2$ k $\Omega$	25°C	120			120			dB
$I_{OS}$ Short-circuit output current	$V_O = 0$	25°C	$V_{ID} = 1$ V			-35			mA
			$V_{ID} = -1$ V			45			

† Full range is  $-55^\circ\text{C}$  to  $125^\circ\text{C}$ .

**TLE2074M operating characteristics at specified free-air temperature,  $V_{CC\pm} = \pm 5$  V**

PARAMETER	TEST CONDITIONS	$T_A$ †	TLE2074M			TLE2074AM			UNIT	
			MIN	TYP	MAX	MIN	TYP	MAX		
SR+ Positive slew rate	$V_{O(PP)} = \pm 2.3$ V, $A_{VD} = -1$ , $C_L = 100$ pF, $R_L = 2$ k $\Omega$ , See Figure 1	25°C	35			35			V/ $\mu$ s	
		Full range	18‡			18‡				
SR- Negative slew rate		25°C	38			38			V/ $\mu$ s	
		Full range	18‡			18‡				
$t_s$ Settling time	$A_{VD} = -1$ , 2-V step, $R_L = 1$ k $\Omega$ , $C_L = 100$ pF	25°C	To 10 mV			0.25			$\mu$ s	
			To 1 mV			0.4				
$V_n$ Equivalent input noise voltage	$R_S = 20$ $\Omega$ , See Figure 3	25°C	$f = 10$ Hz			28			nV/ $\sqrt{\text{Hz}}$	
			$f = 10$ kHz			11.6				
$V_{N(PP)}$ Peak-to-peak equivalent input noise voltage		25°C	$f = 10$ Hz to 10 kHz			6			$\mu$ V	
			$f = 0.1$ Hz to 10 Hz			0.6				
$I_n$ Equivalent input noise current	$V_{IC} = 0$ , $f = 10$ kHz	25°C	2.8			2.8			fA/ $\sqrt{\text{Hz}}$	
THD + N Total harmonic distortion plus noise	$V_{O(PP)} = 5$ V, $f = 1$ kHz, $R_S = 25$ $\Omega$	$A_{VD} = 10$ , $R_L = 2$ k $\Omega$	25°C	0.013%			0.013%			
$B_1$ Unity-gain bandwidth	$V_I = 10$ mV, $C_L = 25$ pF	$R_L = 2$ k $\Omega$ , See Figure 2	25°C	9.4			9.4			MHz
$B_{OM}$ Maximum output-swing bandwidth	$V_{O(PP)} = 4$ V, $R_L = 2$ k $\Omega$	$A_{VD} = -1$ , $C_L = 25$ pF	25°C	2.8			2.8			MHz
$f_m$ Phase margin at unity gain	$V_I = 10$ mV, $C_L = 25$ pF	$R_L = 2$ k $\Omega$ , See Figure 2	25°C	56°			56°			

† Full range is  $-55^\circ\text{C}$  to  $125^\circ\text{C}$ .

‡ On products compliant to MIL-PRF-38535, Class B, this parameter is not production tested.



**TLE207x, TLE207xA**  
**EXCALIBUR LOW-NOISE HIGH-SPEED**  
**JFET-INPUT OPERATIONAL AMPLIFIERS**

SLOS181B – FEBRUARY 1997 – REVISED APRIL 2004

**TLE2074M electrical characteristics at specified free-air temperature,  $V_{CC\pm} = \pm 15\text{ V}$  (unless otherwise noted)**

PARAMETER	TEST CONDITIONS	$T_A$ †	TLE2074M			TLE2074AM			UNIT	
			MIN	TYP	MAX	MIN	TYP	MAX		
$V_{IO}$ Input offset voltage	$V_{IC} = 0, V_O = 0,$ $R_S = 50\ \Omega$	25°C	-1.6	5		-0.5	3		mV	
		Full range			10.5		8.5			
$\alpha_{VIO}$ Temperature coefficient of input offset voltage		Full range	10.1	30‡		10.1	30‡		$\mu\text{V}/^\circ\text{C}$	
$I_{IO}$ Input offset current	$V_{IC} = 0, V_O = 0,$ See Figure 4	25°C	15	100		15	100		pA	
		Full range		20			20		nA	
$I_{IB}$ Input bias current		25°C	25	175		25	175		pA	
		Full range		60			60		nA	
$V_{ICR}$ Common-mode input voltage range	$R_S = 50\ \Omega$	25°C	15 to -11	15 to -11.9		15 to -11	15 to -11.9		V	
		Full range	15 to -10.8			15 to -10.8				
$V_{OM+}$ Maximum positive peak output voltage swing	$I_O = -200\ \mu\text{A}$	25°C	13.8	14.1		13.8	14.1		V	
		Full range	13.6			13.6				
	$I_O = -2\ \text{mA}$	25°C	13.5	13.9		13.5	13.9			
		Full range	13.3			13.3				
	$I_O = -20\ \text{mA}$	25°C	11.5	12.3		11.5	12.3			
		Full range	11.4			11.4				
$V_{OM-}$ Maximum negative peak output voltage swing	$I_O = 200\ \mu\text{A}$	25°C	-13.8	-14.2		-13.8	-14.2		V	
		Full range	-13.6			-13.6				
	$I_O = 2\ \text{mA}$	25°C	-13.5	-14		-13.5	-14			
		Full range	-13.3			-13.3				
	$I_O = 20\ \text{mA}$	25°C	-11.5	-12.4		-11.5	-12.4			
		Full range	-11.4			-11.4				
$A_{VD}$ Large-signal differential voltage amplification	$V_O = \pm 10\ \text{V}$	$R_L = 600\ \Omega$	25°C	80	96		80	96	dB	
			Full range	78			78			
		$R_L = 2\ \text{k}\Omega$	25°C	90	109		90	109		
			Full range	88			88			
		$R_L = 10\ \text{k}\Omega$	25°C	95	118		95	118		
			Full range	93			93			
$r_i$ Input resistance	$V_{IC} = 0$	25°C	$10^{12}$			$10^{12}$			$\Omega$	
$c_i$ Input capacitance	Common mode	$V_{IC} = 0,$ See Figure 5	25°C	7.5			7.5			pF
	Differential		25°C	2.5			2.5			
$z_o$ Open-loop output impedance	$f = 1\ \text{MHz}$	25°C	80			80			$\Omega$	
CMRR Common-mode rejection ratio	$V_{IC} = V_{ICRmin},$ $V_O = 0, R_S = 50\ \Omega$	25°C	80	98		80	98		dB	
		Full range	78			78				
$k_{SVR}$ Supply-voltage rejection ratio ( $\Delta V_{CC\pm}/\Delta V_{IO}$ )	$V_{CC\pm} = \pm 5\ \text{V to } \pm 15\ \text{V},$ $V_O = 0, R_S = 50\ \Omega$	25°C	82	99		82	99		dB	
		Full range	80			80				

† Full range is  $-55^\circ\text{C}$  to  $125^\circ\text{C}$ .

‡ On products compliant to MIL-PRF-38535, Class B, this parameter is not production tested.



# TLE207x, TLE207xA EXCALIBUR LOW-NOISE HIGH-SPEED JFET-INPUT OPERATIONAL AMPLIFIERS

SLOS181B – FEBRUARY 1997 – REVISED APRIL 2004

**TLE2074M electrical characteristics at specified free-air temperature,  $V_{CC\pm} = \pm 15$  V (unless otherwise noted) (continued)**

PARAMETER	TEST CONDITIONS	$T_A$ †	TLE2074M			TLE2074AM			UNIT	
			MIN	TYP	MAX	MIN	TYP	MAX		
$I_{CC}$	Supply current (four amplifiers)	$V_O = 0$ , No load	25°C	5.2	6.5	7.5	5.2	6.5	7.5	mA
			Full range	7.5			7.5			
	Crosstalk attenuation	$V_{IC} = 0$ , $R_L = 2$ k $\Omega$	25°C	120			120			dB
$I_{OS}$	Short-circuit output current	$V_O = 0$	25°C	$V_{ID} = 1$ V	-30	-45	-30	-45	mA	
				$V_{ID} = -1$ V	30	48	30	48		

† Full range is  $-55^\circ\text{C}$  to  $125^\circ\text{C}$ .

**TLE2074M operating characteristics at specified free-air temperature,  $V_{CC\pm} = \pm 15$  V**

PARAMETER	TEST CONDITIONS	$T_A$ †	TLE2074M			TLE2074AM			UNIT	
			MIN	TYP	MAX	MIN	TYP	MAX		
SR+	Positive slew rate	$V_{O(PP)} = 10$ V, $R_L = 2$ k $\Omega$ , $C_L = 100$ pF, See Figure 1	25°C	25	40		25	40	V/ $\mu$ s	
			Full range	17			17			
SR-	Negative slew rate	See Figure 1	25°C	30	45		30	45	V/ $\mu$ s	
			Full range	20			20			
$t_s$	Settling time	$A_{VD} = -1$ , 10-V step, $R_L = 1$ k $\Omega$ , $C_L = 100$ pF	To 10 mV	0.4			0.4			$\mu$ s
			To 1 mV	1.5			1.5			
$V_n$	Equivalent input noise voltage	$R_S = 20$ $\Omega$ , See Figure 3	f = 10 Hz	28	55‡		28	55‡	nV/ $\sqrt{\text{Hz}}$	
			f = 10 kHz	11.6	17‡		11.6	17‡		
$V_{N(PP)}$	Peak-to-peak equivalent input noise voltage	See Figure 3	f = 10 Hz to 10 kHz	6			6			$\mu$ V
			f = 0.1 Hz to 10 Hz	0.6			0.6			
$I_n$	Equivalent input noise current	$V_{IC} = 0$ , f = 10 kHz	25°C	2.8			2.8			fA/ $\sqrt{\text{Hz}}$
THD + N	Total harmonic distortion plus noise	$V_{O(PP)} = 20$ V, f = 1 kHz, $R_S = 25$ $\Omega$	25°C	0.008%			0.008%			
$B_1$	Unity-gain bandwidth	$V_I = 10$ mV, $C_L = 25$ pF, $R_L = 2$ k $\Omega$ , See Figure 2	25°C	8‡	10		8‡	10	MHz	
$B_{OM}$	Maximum output-swing bandwidth	$V_{O(PP)} = 20$ V, $R_L = 2$ k $\Omega$ , $A_{VD} = -1$ , $C_L = 25$ pF	25°C	478‡	637		478‡	637	kHz	
$\phi_m$	Phase margin at unity gain	$V_I = 10$ mV, $C_L = 25$ pF, $R_L = 2$ k $\Omega$ , See Figure 2	25°C	57°			57°			

† Full range is  $-55^\circ\text{C}$  to  $125^\circ\text{C}$ .

‡ On products compliant to MIL-PRF-38535, Class B, this parameter is not production tested.



**TLE207x, TLE207xA**  
**EXCALIBUR LOW-NOISE HIGH-SPEED**  
**JFET-INPUT OPERATIONAL AMPLIFIERS**

SLOS181B – FEBRUARY 1997 – REVISED APRIL 2004

**TLE2074Y electrical characteristics at  $V_{CC\pm} = \pm 15\text{ V}$ ,  $T_A = 25^\circ\text{C}$  (unless otherwise noted)**

PARAMETER		TEST CONDITIONS		TLE2074Y			UNIT
				MIN	TYP	MAX	
$V_{IO}$	Input offset voltage	$V_{IC} = 0$ , $R_S = 50\ \Omega$	$V_O = 0$ ,			5	mV
$I_{IO}$	Input offset current	$V_{IC} = 0$ , See Figure 4	$V_O = 0$ ,		15	100	pA
$I_{IB}$	Input bias current				25	175	pA
$V_{ICR}$	Common-mode input voltage range	$R_S = 50\ \Omega$		15 to -11	15 to 11.9		V
$V_{OM+}$	Maximum positive peak output voltage swing	$I_O = -200\ \mu\text{A}$		13.8	14.1		V
		$I_O = -2\ \text{mA}$		13.5	13.9		
		$I_O = -20\ \text{mA}$		11.5	12.3		
$V_{OM-}$	Maximum negative peak output voltage swing	$I_O = 200\ \mu\text{A}$		-13.8	-14.2		V
		$I_O = 2\ \text{mA}$		-13.5	-14		
		$I_O = 20\ \text{mA}$		-11.5	-12.4		
$A_{VD}$	Large-signal differential voltage amplification	$V_O = \pm 10\ \text{V}$	$R_L = 600\ \Omega$	80	96		dB
			$R_L = 2\ \text{k}\Omega$	90	109		
			$R_L = 10\ \text{k}\Omega$	95	118		
$r_i$	Input resistance	$V_{IC} = 0$			$10^{12}$		$\Omega$
$c_i$	Input capacitance	Common mode	$V_O = 0$ , See Figure 5		7.5		pF
		Differential			2.5		
$z_o$	Open-loop output impedance	$f = 1\ \text{MHz}$			80		$\Omega$
CMRR	Common-mode rejection ratio	$V_{IC} = V_{ICR}^{\text{min}}$ , $R_S = 50\ \Omega$	$V_O = 0$ ,	80	98		dB
$k_{SVR}$	Supply-voltage rejection ratio ( $\Delta V_{CC\pm}/\Delta V_{IO}$ )	$V_{CC\pm} = \pm 5\ \text{V}$ to $\pm 15\ \text{V}$ , $V_O = 0$ ,	$R_S = 50\ \Omega$	82	99		dB
$I_{CC}$	Supply current (four amplifiers)	$V_O = 0$ ,	No load	5.2	6.5	7.5	mA
$I_{OS}$	Short-circuit output current	$V_O = 0$	$V_{ID} = 1\ \text{V}$	-30	-45		mA
			$V_{ID} = -1\ \text{V}$	30	48		

# TLE207x, TLE207xA EXCALIBUR LOW-NOISE HIGH-SPEED JFET-INPUT OPERATIONAL AMPLIFIERS

SLOS181B – FEBRUARY 1997 – REVISED APRIL 2004

## PARAMETER MEASUREMENT INFORMATION

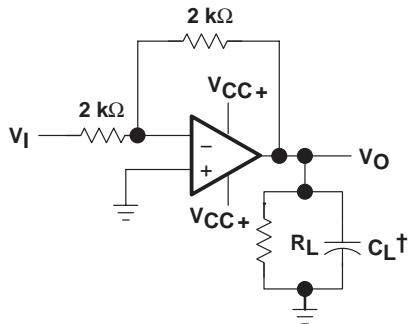

† Includes fixture capacitance

**Figure 1. Slew-Rate Test Circuit**

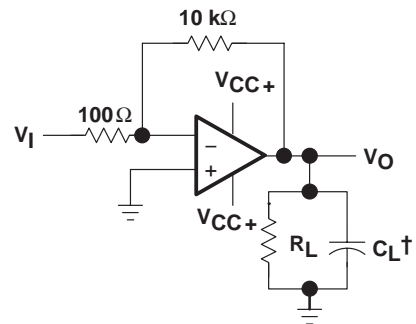

† Includes fixture capacitance

**Figure 2. Unity-Gain Bandwidth and Phase-Margin Test Circuit**

**PARAMETER MEASUREMENT INFORMATION**

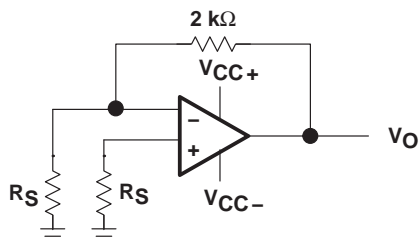

**Figure 3. Noise-Voltage Test Circuit**

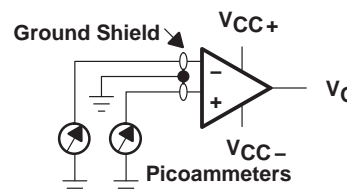

**Figure 4. Input-Bias and Offset-Current Test Circuit**

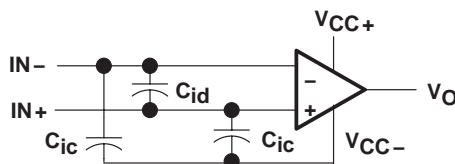

**Figure 5. Internal Input Capacitance**

**typical values**

Typical values presented in this data sheet represent the median (50% point) of device parametric performance.

**input bias and offset current**

At the picoampere bias current level typical of the TLE207x and TLE207xA, accurate measurement of the bias current becomes difficult. Not only does this measurement require a picoammeter but test socket leakages can easily exceed the actual device bias currents. To accurately measure these small currents, Texas Instruments uses a two-step process. The socket leakage is measured using picoammeters with bias voltages applied but with no device in the socket. The device is then inserted in the socket and a second test is performed that measures both the socket leakage and the device input bias current. The two measurements are then subtracted algebraically to determine the bias current of the device.

**TLE207x, TLE207xA**  
**EXCALIBUR LOW-NOISE HIGH-SPEED**  
**JFET-INPUT OPERATIONAL AMPLIFIERS**

SLOS181B – FEBRUARY 1997 – REVISED APRIL 2004

**TYPICAL CHARACTERISTICS**

**Table of Graphs**

			<b>FIGURE</b>
$V_{IO}$	Input offset voltage	Distribution	6, 7, 8
$\alpha_{VIO}$	Temperature coefficient of input offset voltage	Distribution	9, 10, 11
$I_{IO}$	Input offset current	vs Free-air temperature	12, 13
$I_{IB}$	Input bias current	vs Free-air temperature vs Total supply voltage	12, 13 14
$V_{ICR}$	Common-mode input voltage range	vs Free-air temperature	15
$V_O$	Output voltage	vs Differential input voltage	16, 17
$V_{OM+}$	Maximum positive peak output voltage	vs Output current	18
$V_{OM-}$	Maximum negative peak output voltage	vs Output current	19
$V_{OM}$	Maximum peak output voltage	vs Free-air temperature vs Supply voltage	20, 21 22
$V_{O(PP)}$	Maximum peak-to-peak output voltage	vs Frequency	23
$V_O$	Output voltage	vs Settling time	24
$A_{VD}$	Large-signal differential voltage amplification	vs Load resistance vs Free-air temperature	25 26, 27
$A_{VD}$	Small-signal differential voltage amplification	vs Frequency	28, 29
$CMRR$	Common-mode rejection ratio	vs Frequency vs Free-air temperature	30 31
$k_{SVR}$	Supply-voltage rejection ratio	vs Frequency vs Free-air temperature	32 33
$I_{CC}$	Supply current	vs Supply voltage vs Free-air temperature vs Differential input voltage	34, 35, 36 37, 38, 39 40 – 45
$I_{OS}$	Short-circuit output current	vs Supply voltage vs Elapsed time vs Free-air temperature	46 47 48
$SR$	Slew rate	vs Free-air temperature vs Load resistance vs Differential input voltage	49, 50 51 52
$V_n$	Equivalent Input noise voltage (spectral density)	vs Frequency	53
$V_n$	Input referred noise voltage	vs Noise bandwidth Over a 10-second time interval	54 55
	Third-octave spectral noise density	vs Frequency bands	56
$THD + N$	Total harmonic distortion plus noise	vs Frequency	57, 58
$B_1$	Unity-gain bandwidth	vs Load capacitance	59
	Gain-bandwidth product	vs Free-air temperature vs Supply voltage	60 61
	Gain margin	vs Load capacitance	62
$\phi_m$	Phase margin	vs Free-air temperature vs Supply voltage vs Load capacitance	63 64 65
	Phase shift	vs Frequency	28, 29
	Noninverting large-signal pulse response	vs Time	66
	Small-signal pulse response	vs Time	67
$z_o$	Closed-loop output impedance	vs Frequency	68
	Crosstalk attenuation	vs Frequency	69





**TYPICAL CHARACTERISTICS**

**DISTRIBUTION OF TLE2071  
 INPUT OFFSET VOLTAGE**

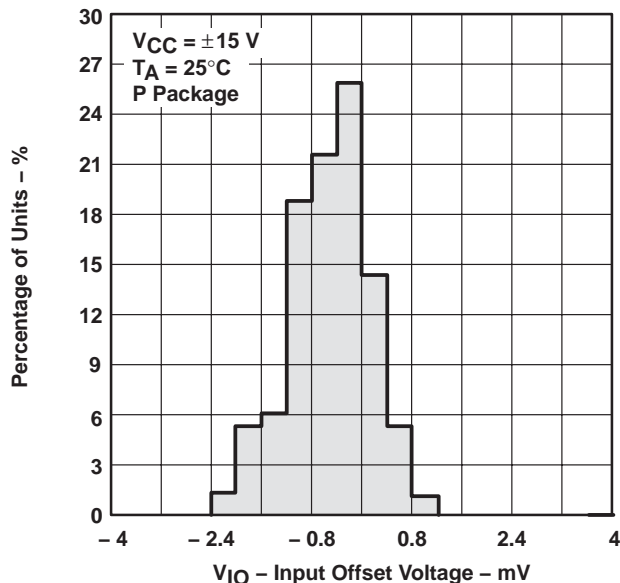

**Figure 6**

**DISTRIBUTION OF TLE2072  
 INPUT OFFSET VOLTAGE**

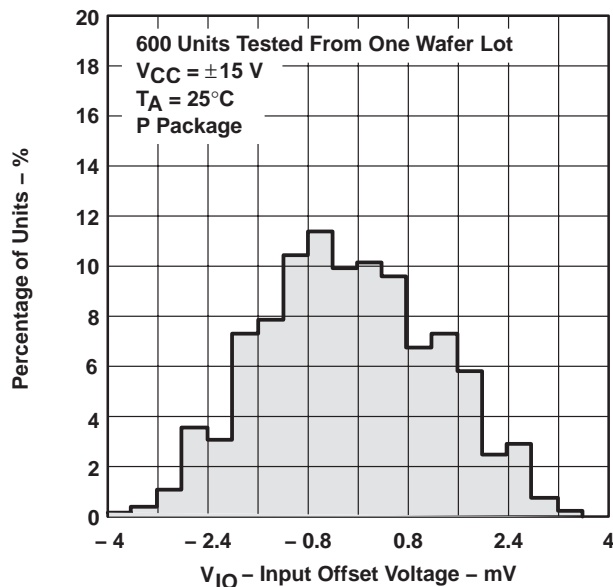

**Figure 7**

**DISTRIBUTION OF TLE2074  
 INPUT OFFSET VOLTAGE**

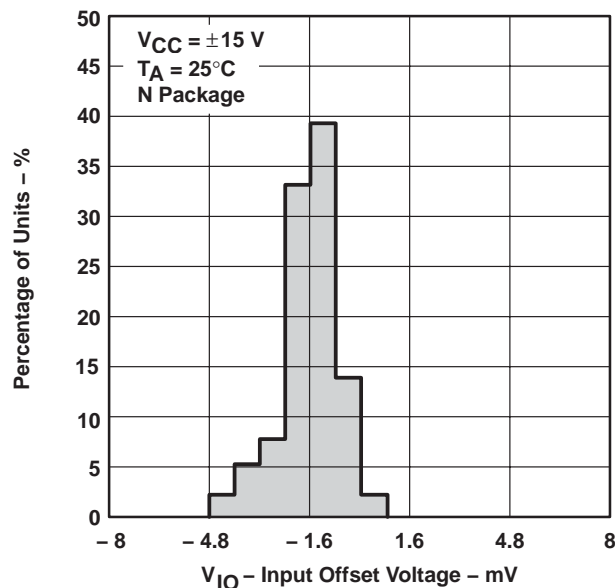

**Figure 8**

**DISTRIBUTION OF TLE2071 INPUT OFFSET  
 VOLTAGE TEMPERATURE COEFFICIENT**

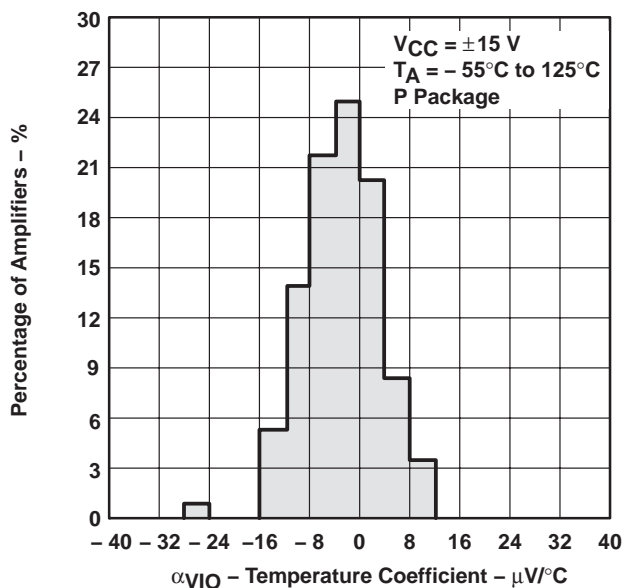

**Figure 9**

# TLE207x, TLE207xA EXCALIBUR LOW-NOISE HIGH-SPEED JFET-INPUT OPERATIONAL AMPLIFIERS

SLOS181B – FEBRUARY 1997 – REVISED APRIL 2004

## TYPICAL CHARACTERISTICS

DISTRIBUTION OF TLE2072 INPUT OFFSET VOLTAGE TEMPERATURE COEFFICIENT

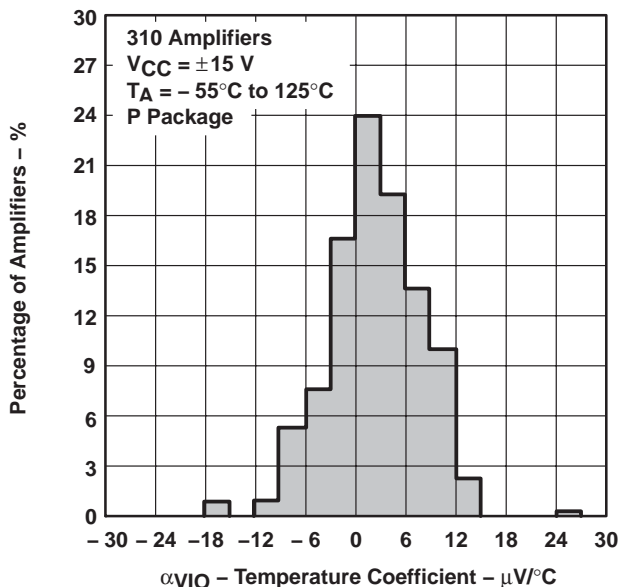

Figure 10

DISTRIBUTION OF TLE2074 INPUT OFFSET VOLTAGE TEMPERATURE COEFFICIENT

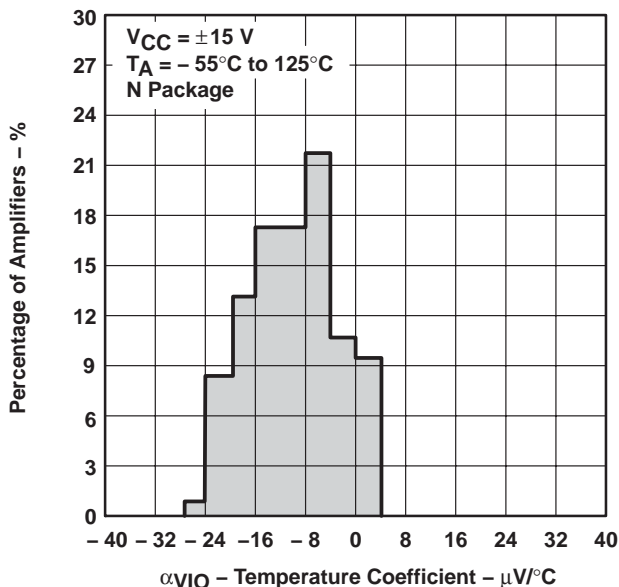

Figure 11

INPUT BIAS CURRENT AND INPUT OFFSET CURRENT†  
vs  
FREE-AIR TEMPERATURE

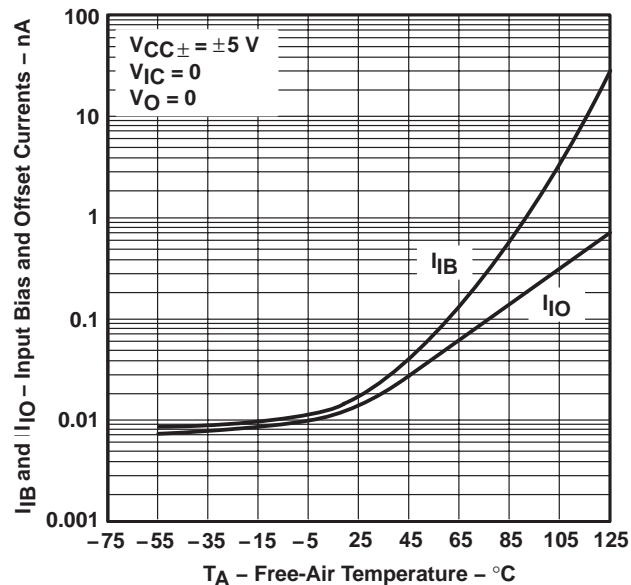

Figure 12

INPUT BIAS CURRENT AND INPUT OFFSET CURRENT†  
vs  
FREE-AIR TEMPERATURE

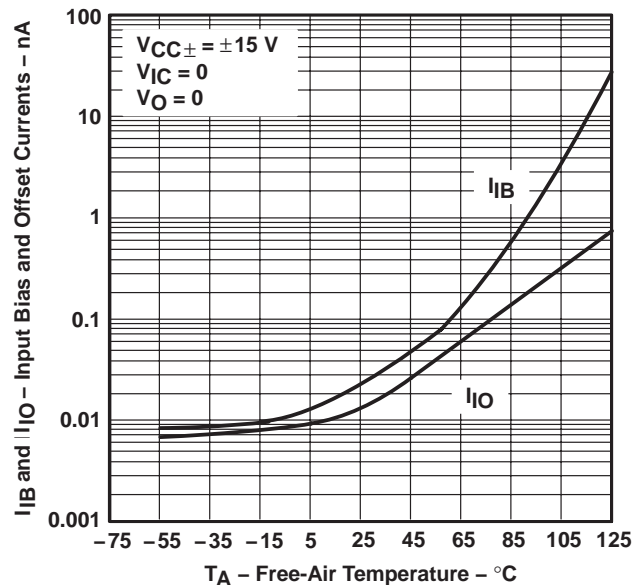
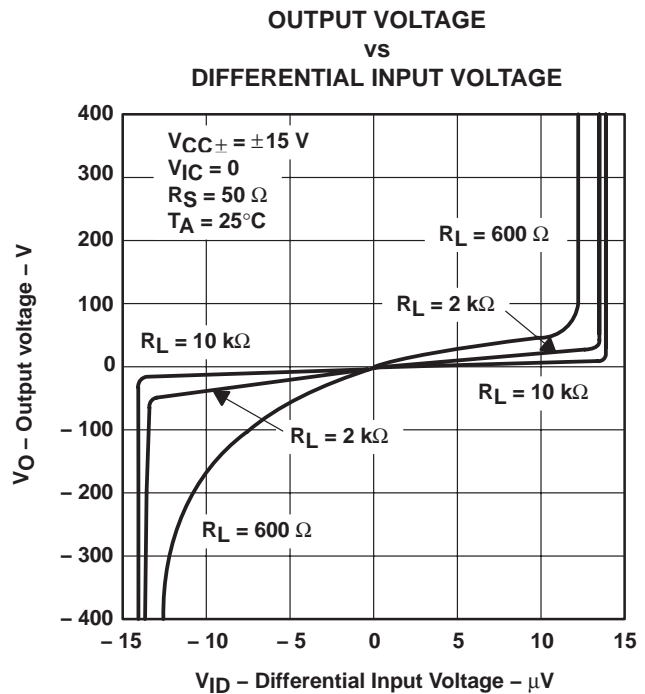
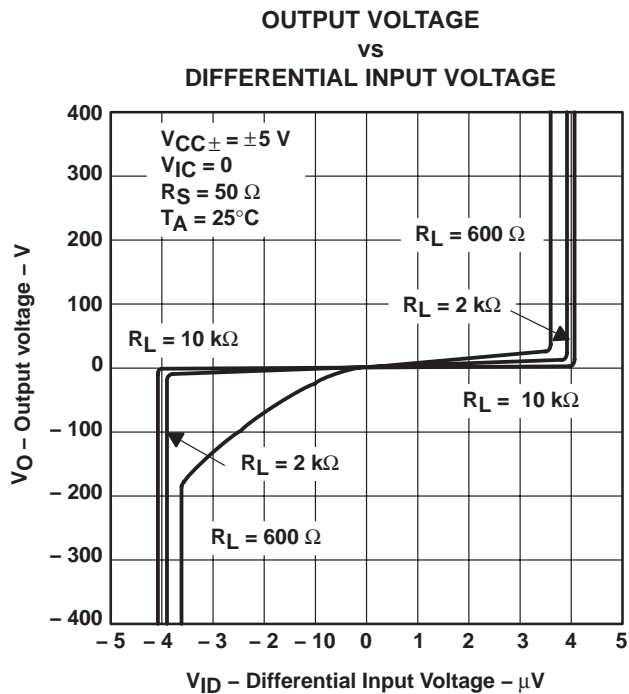
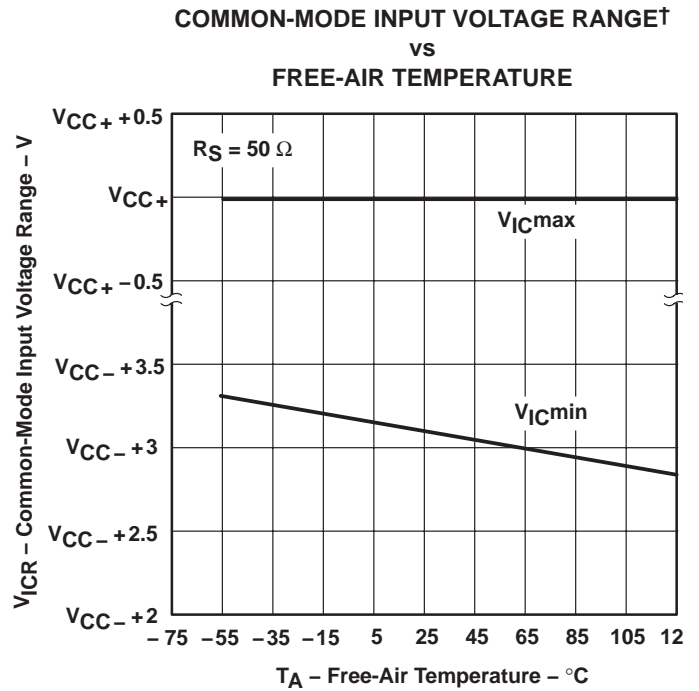
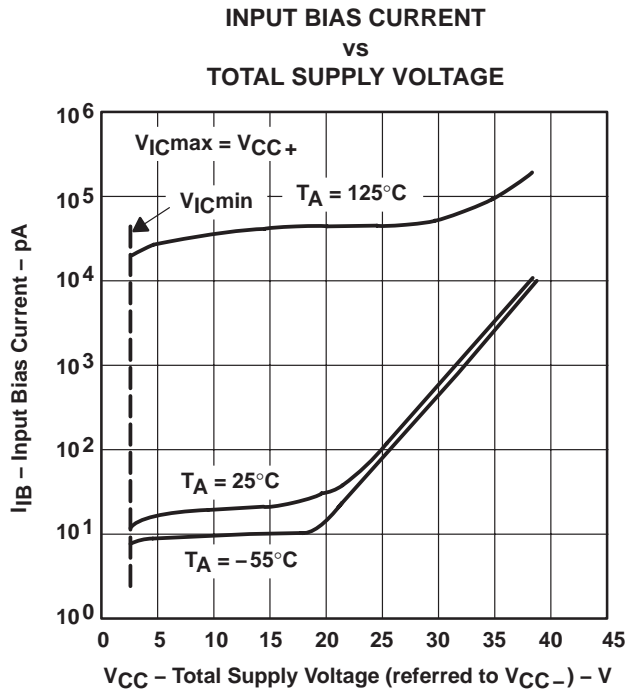

Figure 13

† Data at high and low temperatures are applicable only within the rated operating free-air temperature ranges of the various devices.

**TYPICAL CHARACTERISTICS**



† Data at high and low temperatures are applicable only within the rated operating free-air temperature ranges of the various devices.

**TLE207x, TLE207xA**  
**EXCALIBUR LOW-NOISE HIGH-SPEED**  
**JFET-INPUT OPERATIONAL AMPLIFIERS**

SLOS181B – FEBRUARY 1997 – REVISED APRIL 2004

**TYPICAL CHARACTERISTICS**

**MAXIMUM POSITIVE PEAK OUTPUT VOLTAGE†**  
**vs**  
**OUTPUT CURRENT**

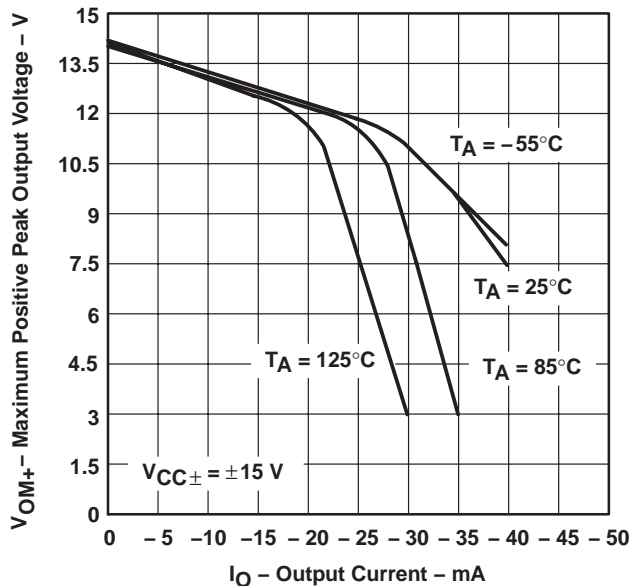

**Figure 18**

**MAXIMUM NEGATIVE PEAK OUTPUT VOLTAGE†**  
**vs**  
**OUTPUT CURRENT**

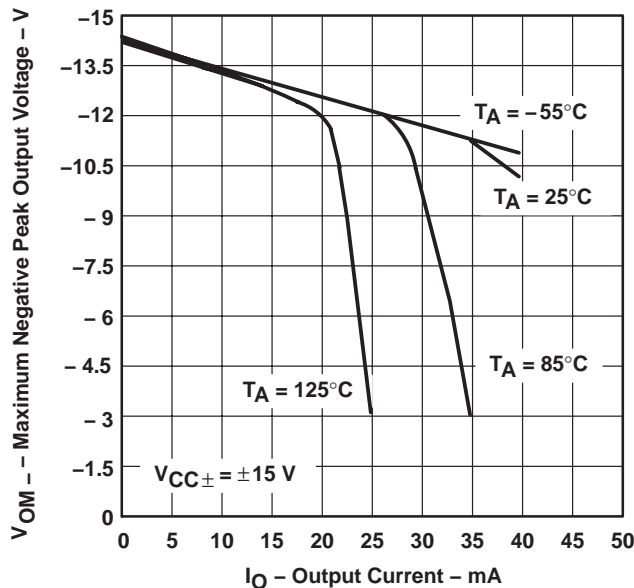

**Figure 19**

**MAXIMUM PEAK OUTPUT VOLTAGE†**  
**vs**  
**FREE-AIR TEMPERATURE**

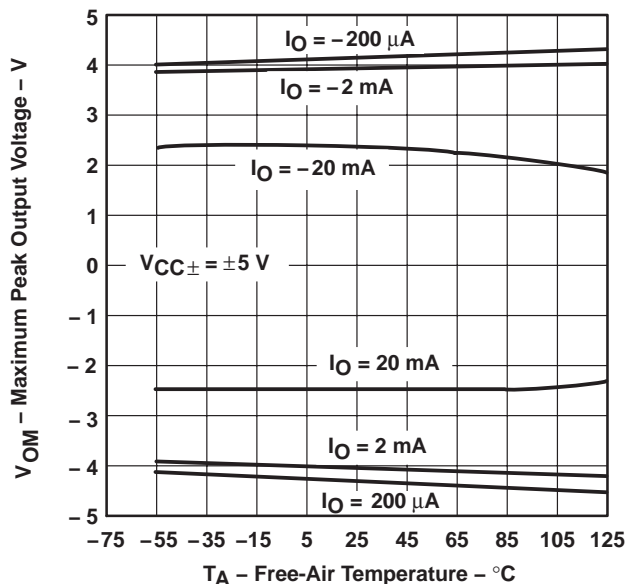

**Figure 20**

**MAXIMUM PEAK OUTPUT VOLTAGE†**  
**vs**  
**FREE-AIR TEMPERATURE**

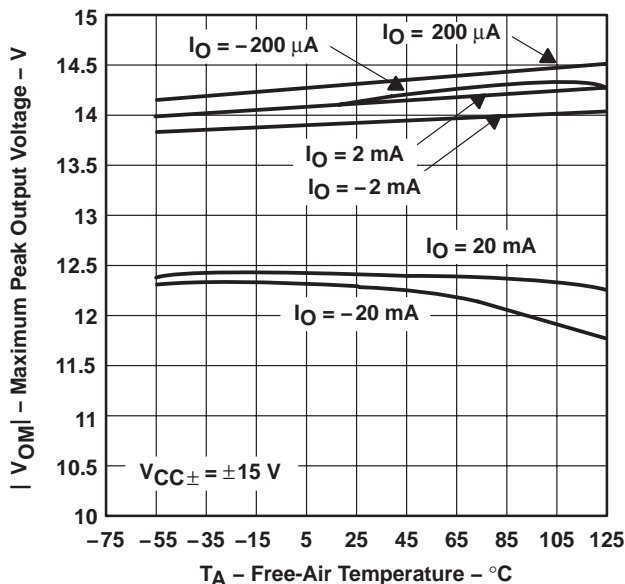
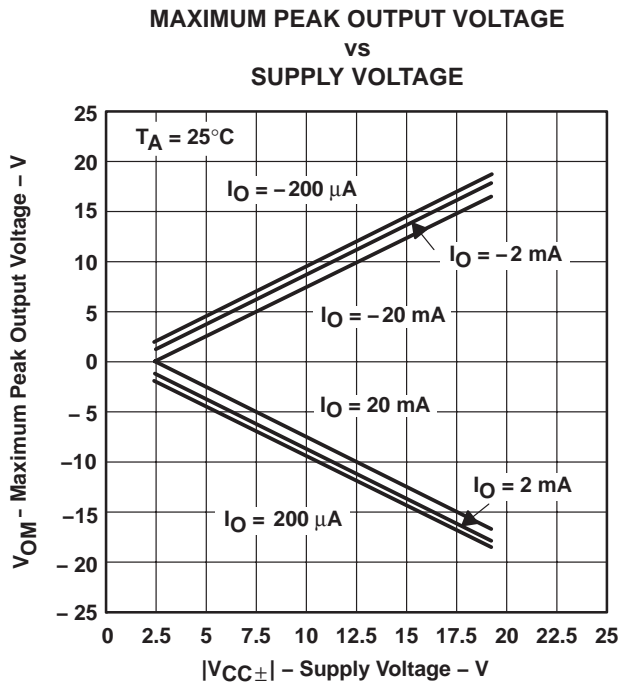

**Figure 21**

† Data at high and low temperatures are applicable only within the rated operating free-air temperature ranges of the various devices.



**TYPICAL CHARACTERISTICS**



**Figure 22**

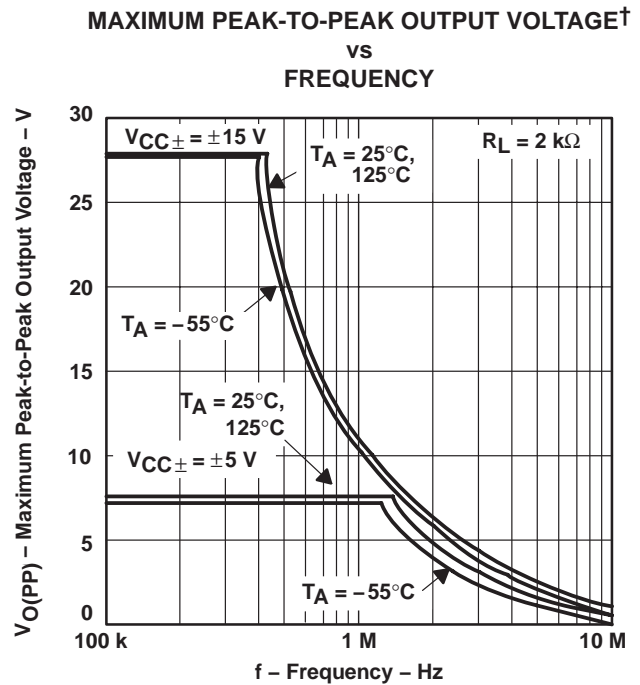

**Figure 23**

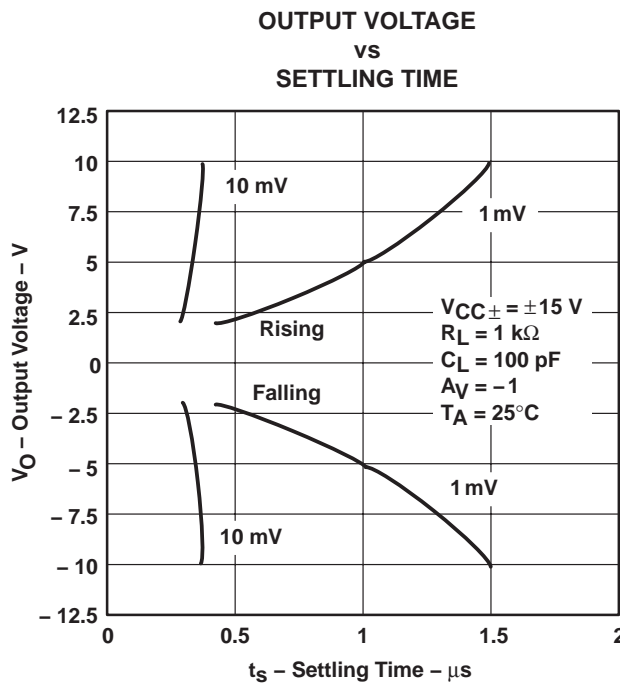

**Figure 24**

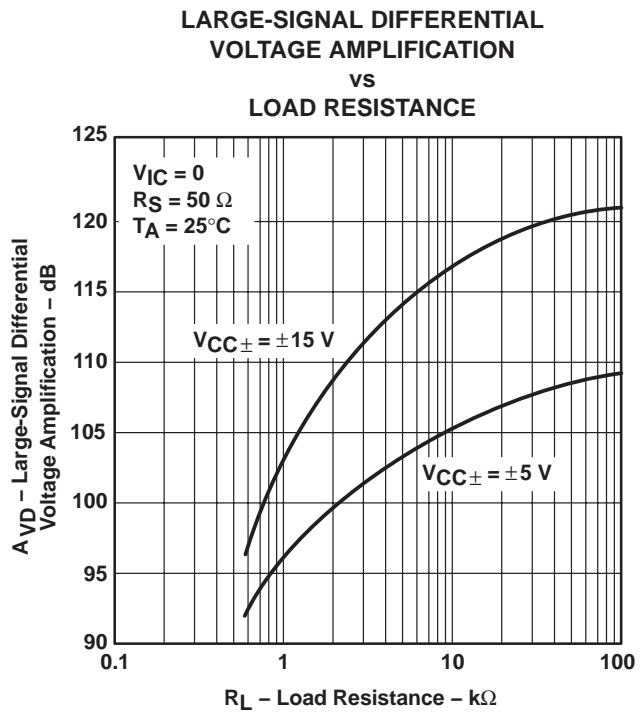

**Figure 25**

† Data at high and low temperatures are applicable only within the rated operating free-air temperature ranges of the various devices.

**TLE207x, TLE207xA**  
**EXCALIBUR LOW-NOISE HIGH-SPEED**  
**JFET-INPUT OPERATIONAL AMPLIFIERS**

SLOS181B – FEBRUARY 1997 – REVISED APRIL 2004

**TYPICAL CHARACTERISTICS**

**LARGE-SIGNAL DIFFERENTIAL  
VOLTAGE AMPLIFICATION†**  
**vs**  
**FREE-AIR TEMPERATURE**

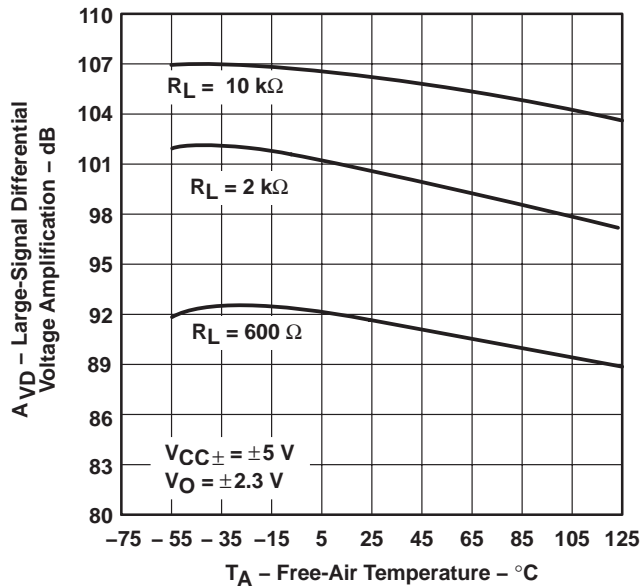

**Figure 26**

**LARGE-SIGNAL DIFFERENTIAL  
VOLTAGE AMPLIFICATION†**  
**vs**  
**FREE-AIR TEMPERATURE**

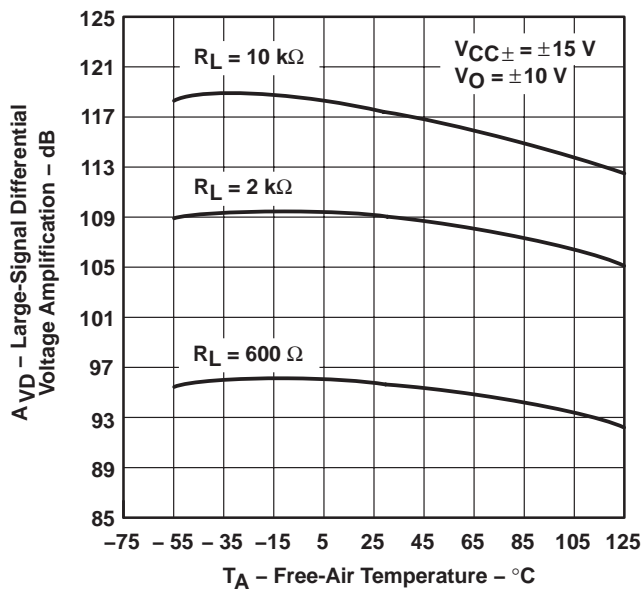

**Figure 27**

† Data at high and low temperatures are applicable only within the rated operating free-air temperature ranges of the various devices.



**TYPICAL CHARACTERISTICS**

**SMALL-SIGNAL DIFFERENTIAL VOLTAGE  
 AMPLIFICATION AND PHASE SHIFT**

vs

**FREQUENCY**

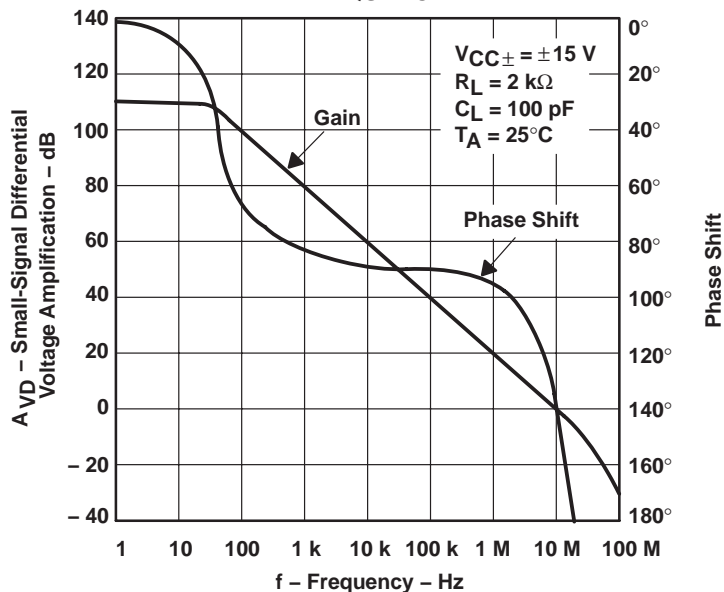

Figure 28

**SMALL-SIGNAL DIFFERENTIAL VOLTAGE  
 AMPLIFICATION AND PHASE SHIFT**

vs

**FREQUENCY**

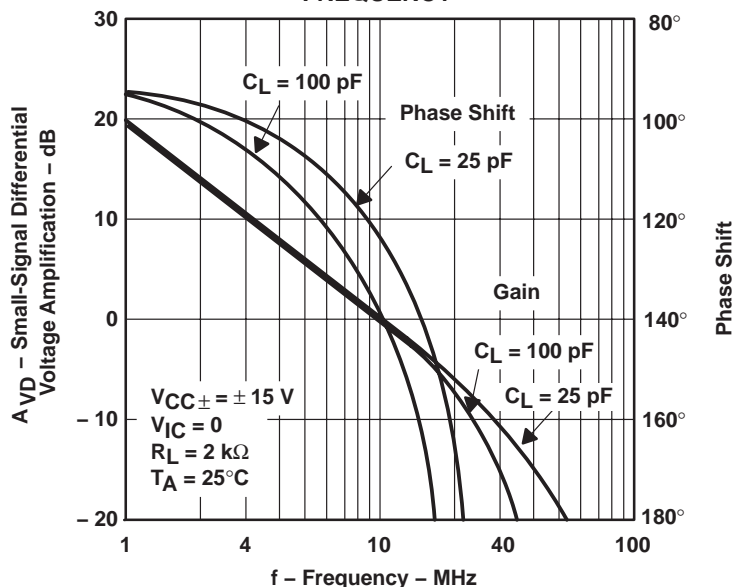

Figure 29

# TLE207x, TLE207xA EXCALIBUR LOW-NOISE HIGH-SPEED JFET-INPUT OPERATIONAL AMPLIFIERS

SLOS181B – FEBRUARY 1997 – REVISED APRIL 2004

## TYPICAL CHARACTERISTICS

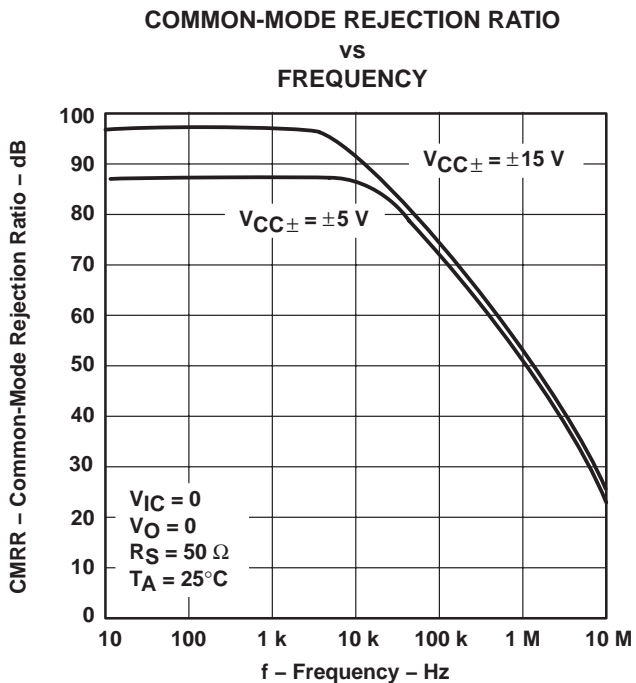

Figure 30

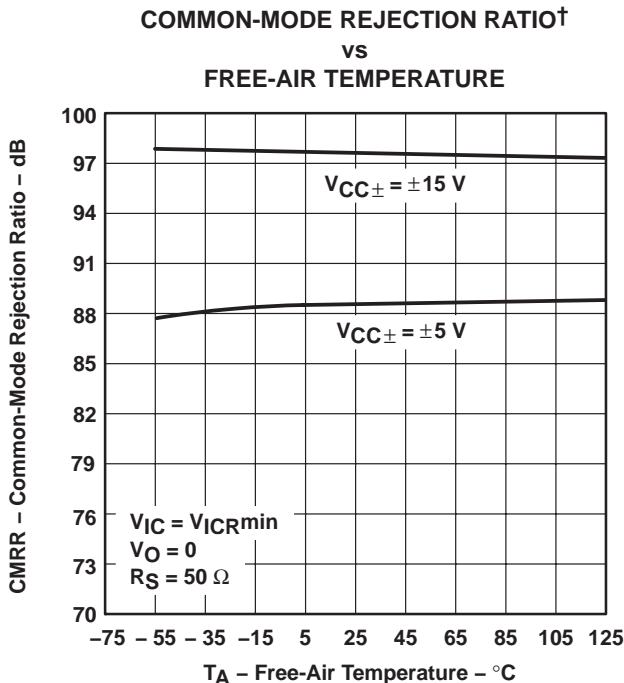

Figure 31

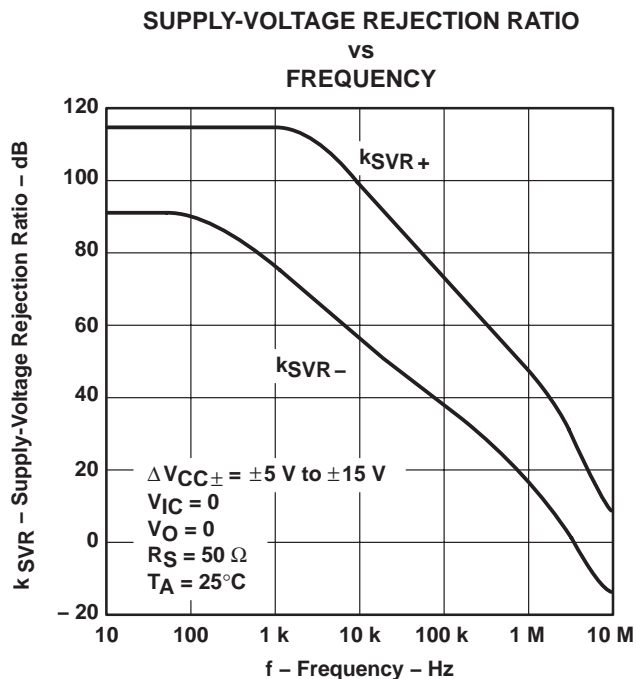

Figure 32

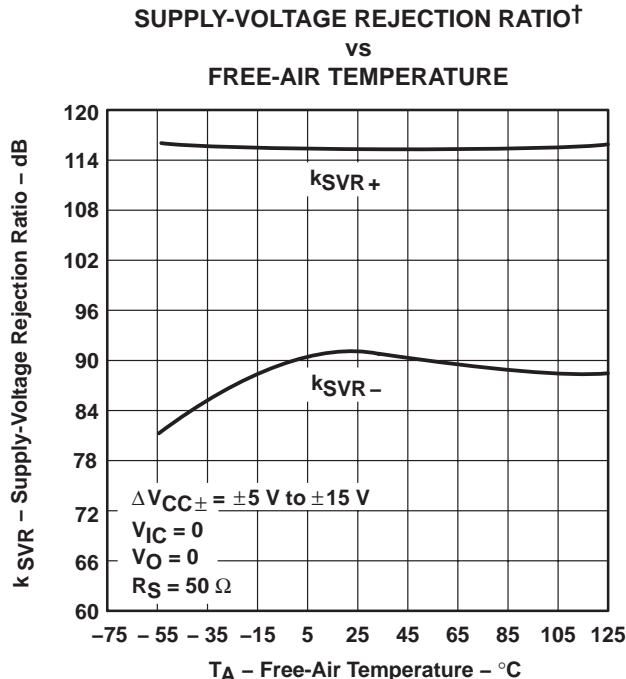
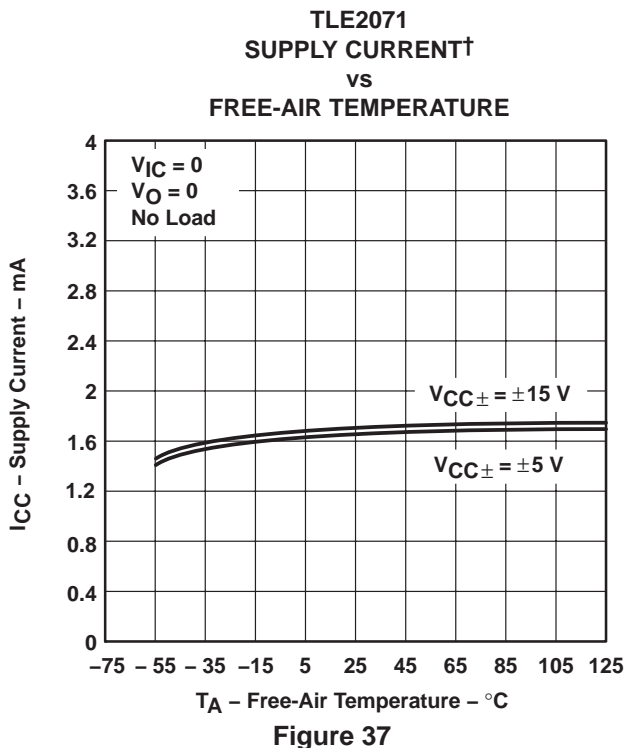
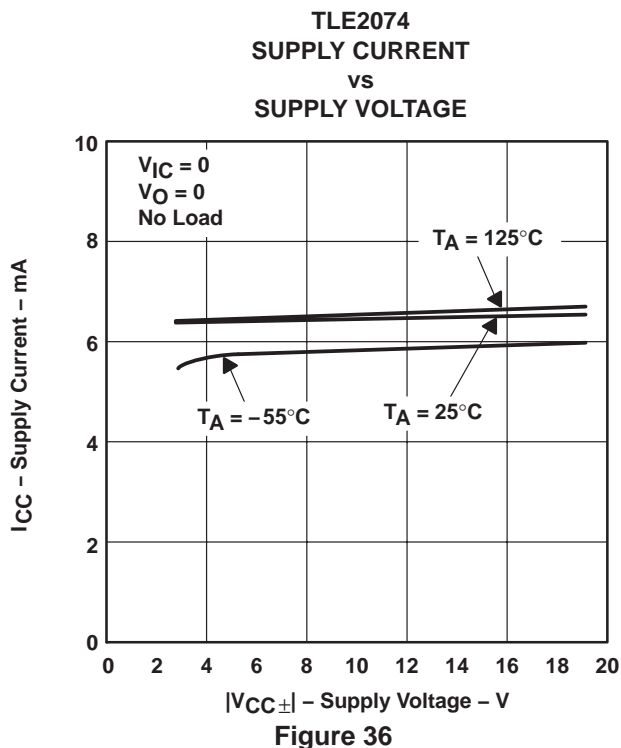
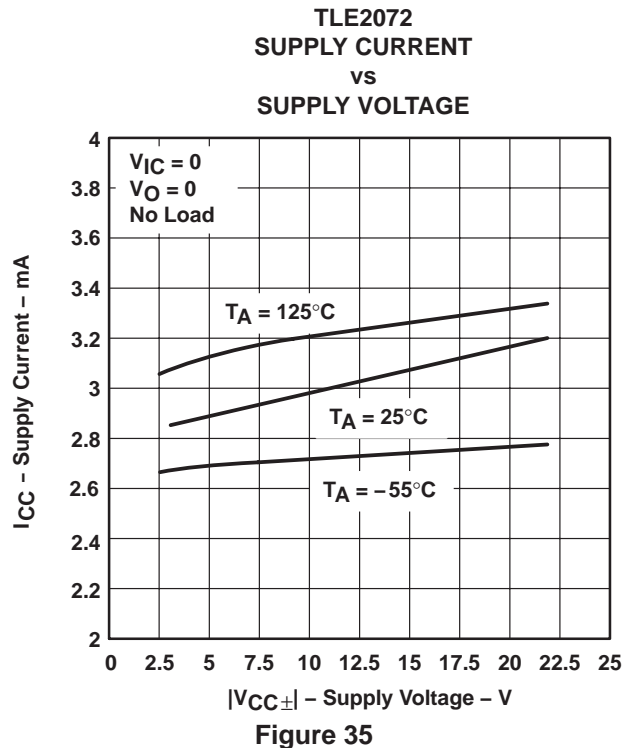
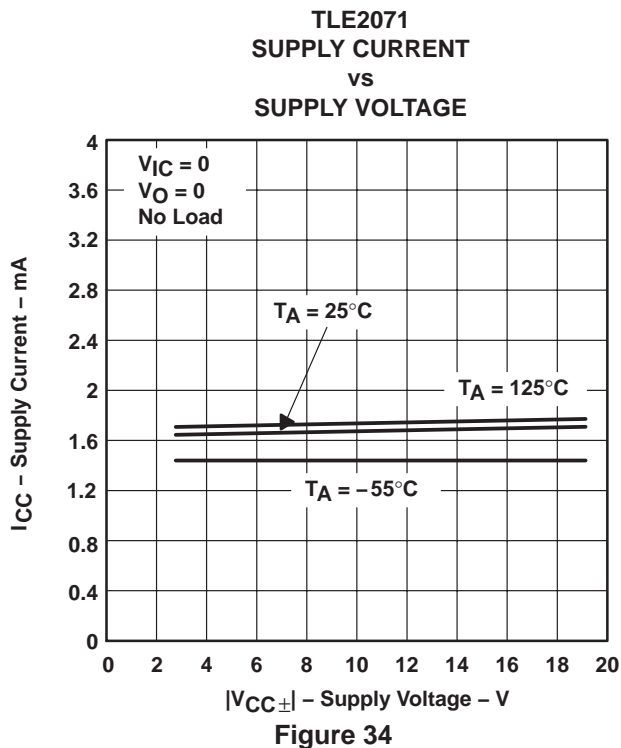

Figure 33

† Data at high and low temperatures are applicable only within the rated operating free-air temperature ranges of the various devices.



TYPICAL CHARACTERISTICS



† Data at high and low temperatures are applicable only within the rated operating free-air temperature ranges of the various devices.

# TLE207x, TLE207xA EXCALIBUR LOW-NOISE HIGH-SPEED JFET-INPUT OPERATIONAL AMPLIFIERS

SLOS181B – FEBRUARY 1997 – REVISED APRIL 2004

## TYPICAL CHARACTERISTICS

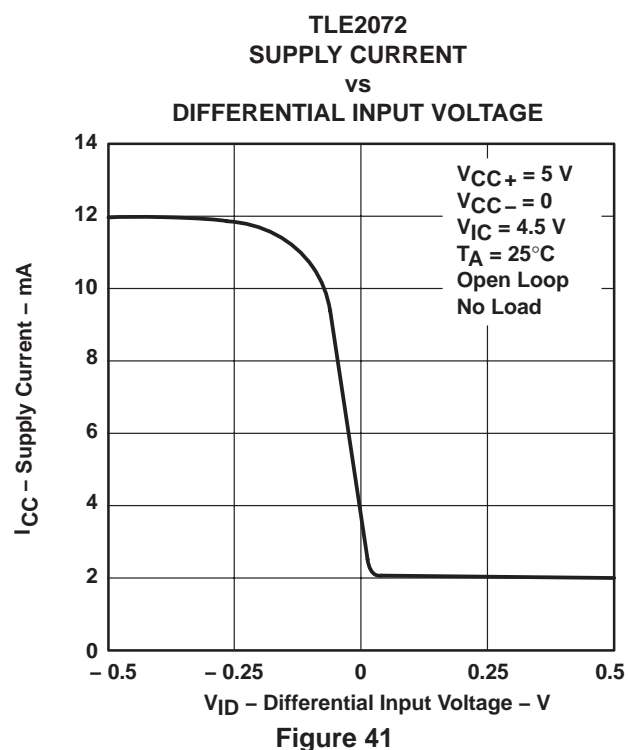
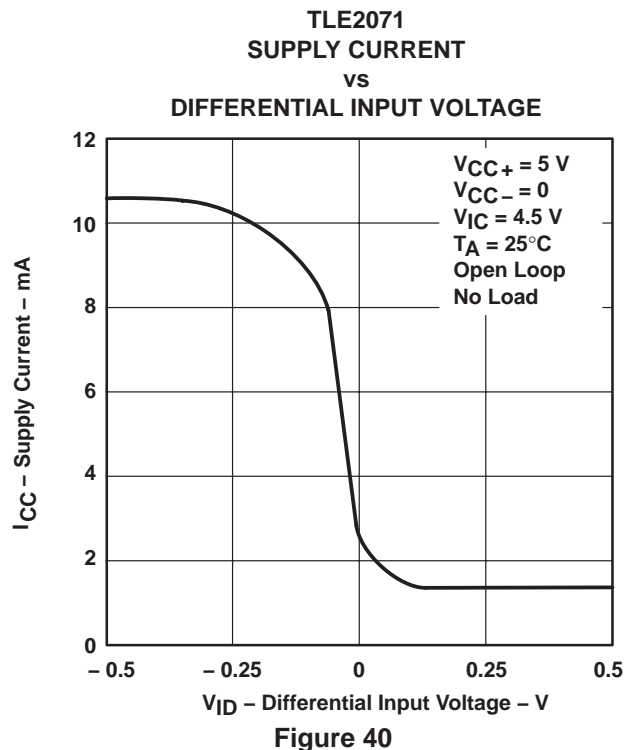
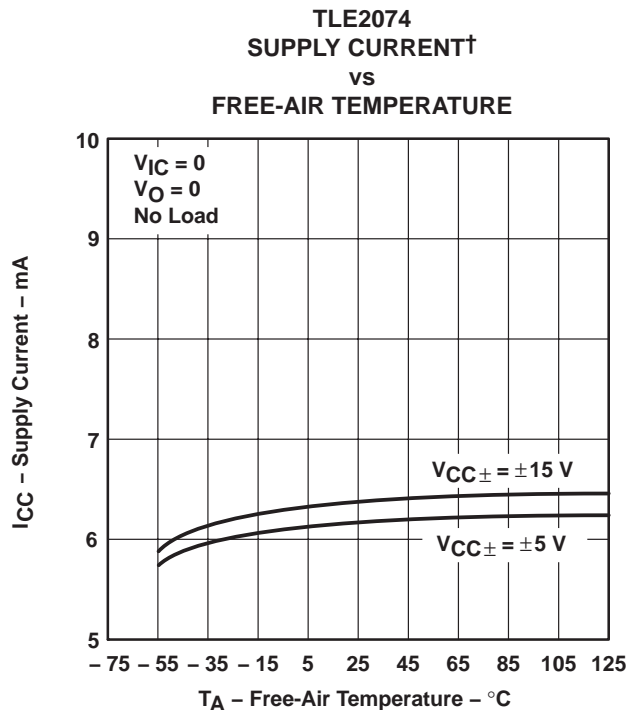
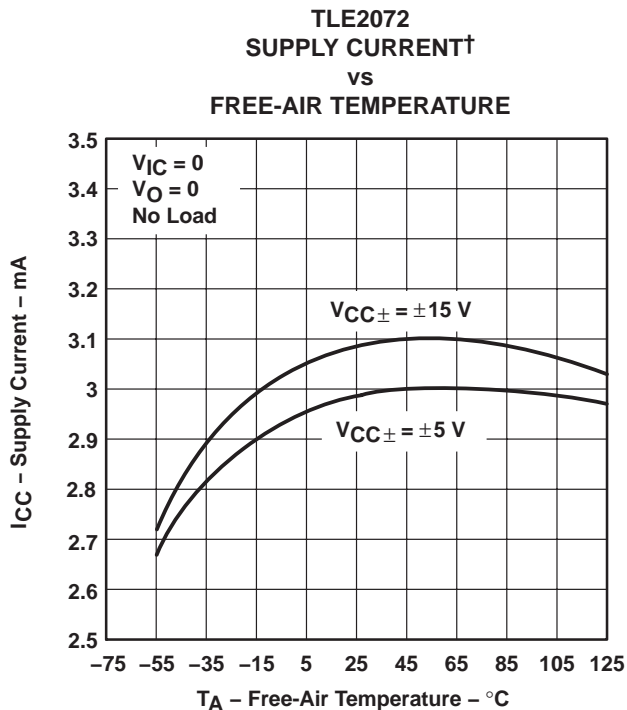

† Data at high and low temperatures are applicable only within the rated operating free-air temperature ranges of the various devices.

TYPICAL CHARACTERISTICS

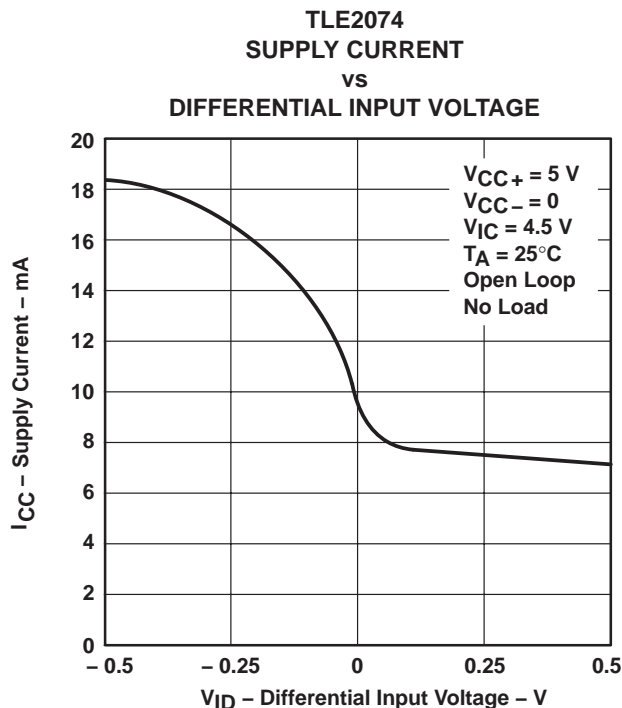

Figure 42

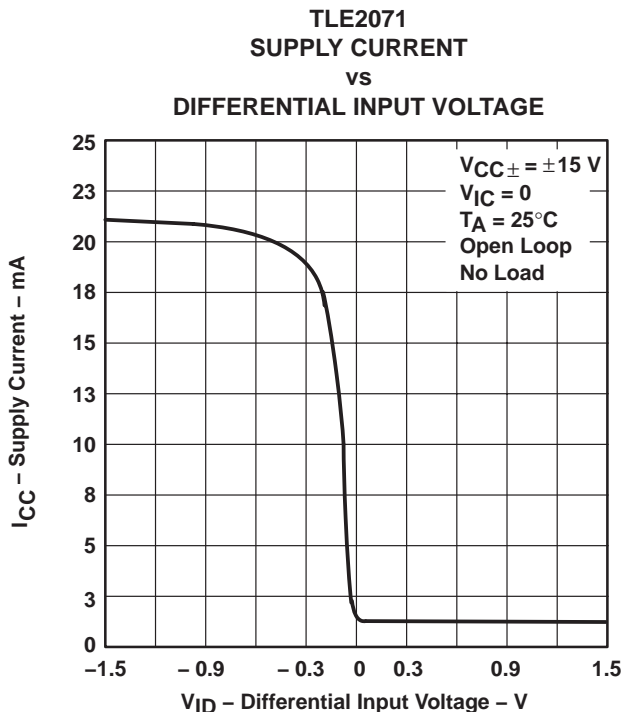

Figure 43

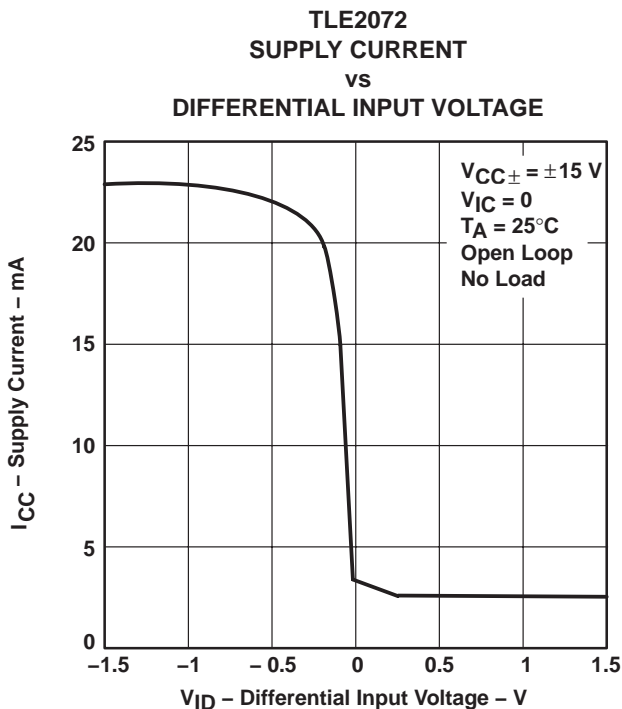

Figure 44

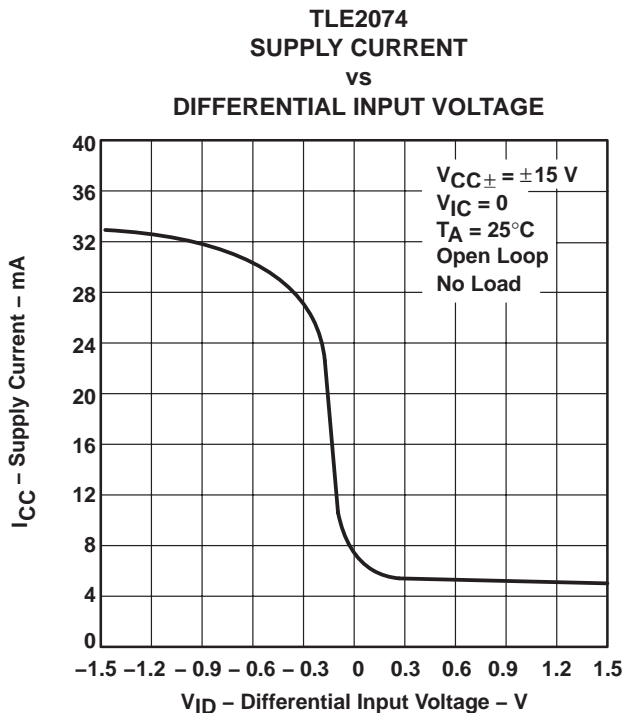

Figure 45

**TLE207x, TLE207xA**  
**EXCALIBUR LOW-NOISE HIGH-SPEED**  
**JFET-INPUT OPERATIONAL AMPLIFIERS**

SLOS181B – FEBRUARY 1997 – REVISED APRIL 2004

**TYPICAL CHARACTERISTICS**

**SHORT-CIRCUIT OUTPUT CURRENT**  
**vs**  
**SUPPLY VOLTAGE**

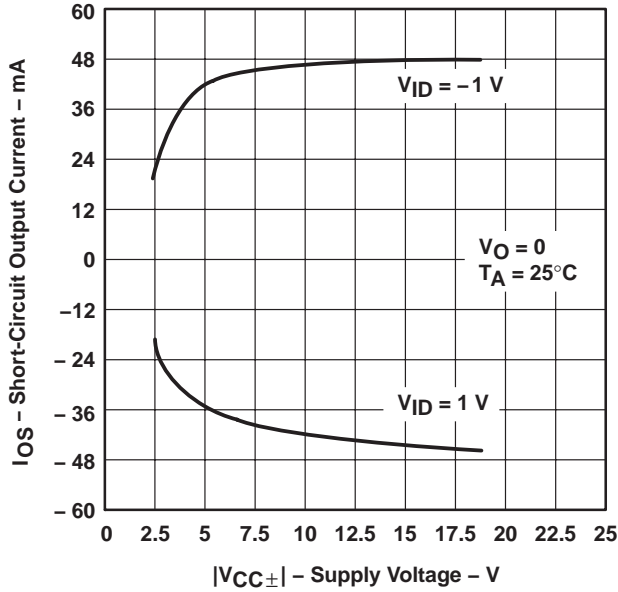

**Figure 46**

**SHORT-CIRCUIT OUTPUT CURRENT**  
**vs**  
**ELAPSED TIME**

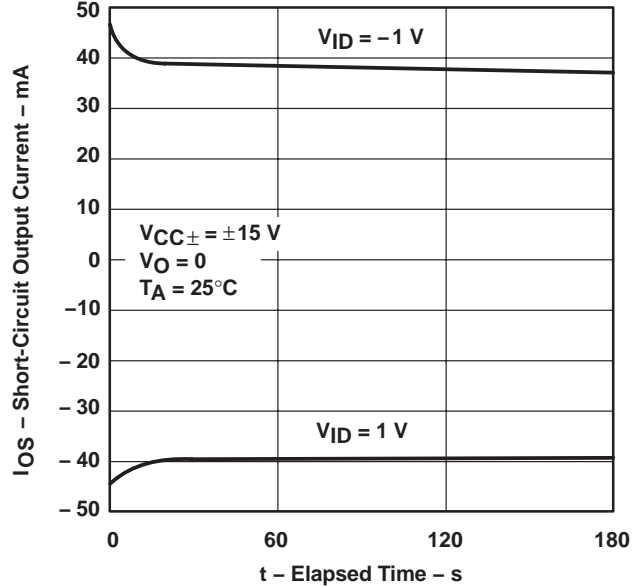

**Figure 47**

**SHORT-CIRCUIT OUTPUT CURRENT†**  
**vs**  
**FREE-AIR TEMPERATURE**

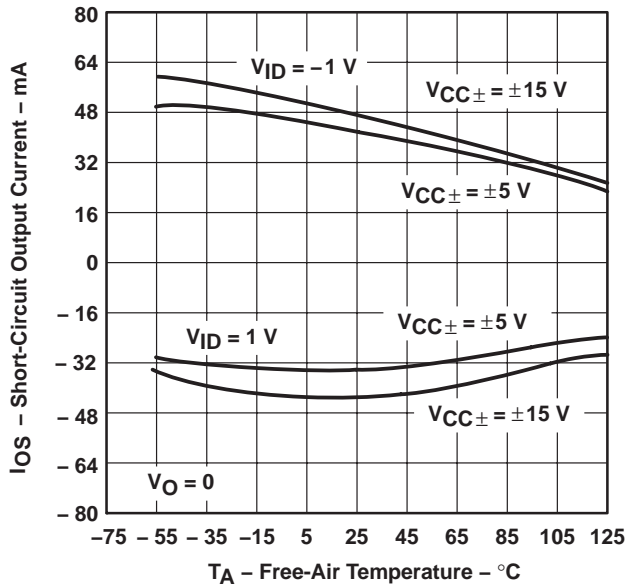

**Figure 48**

**SLEW RATE†**  
**vs**  
**FREE-AIR TEMPERATURE**

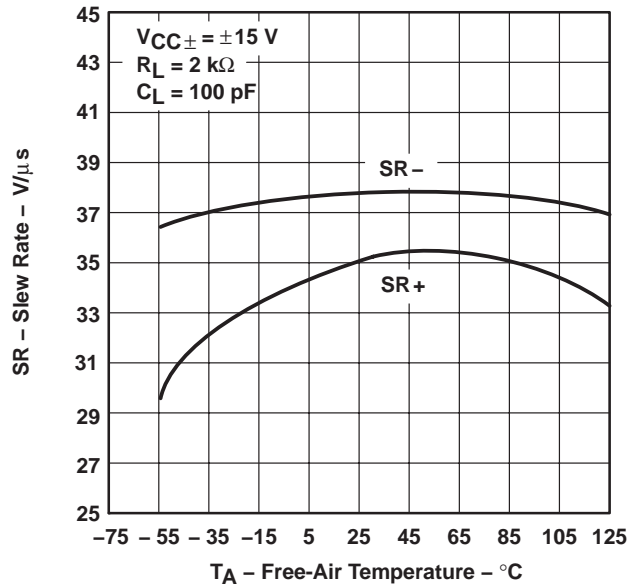

**Figure 49**

† Data at high and low temperatures are applicable only within the rated operating free-air temperature ranges of the various devices.



TYPICAL CHARACTERISTICS

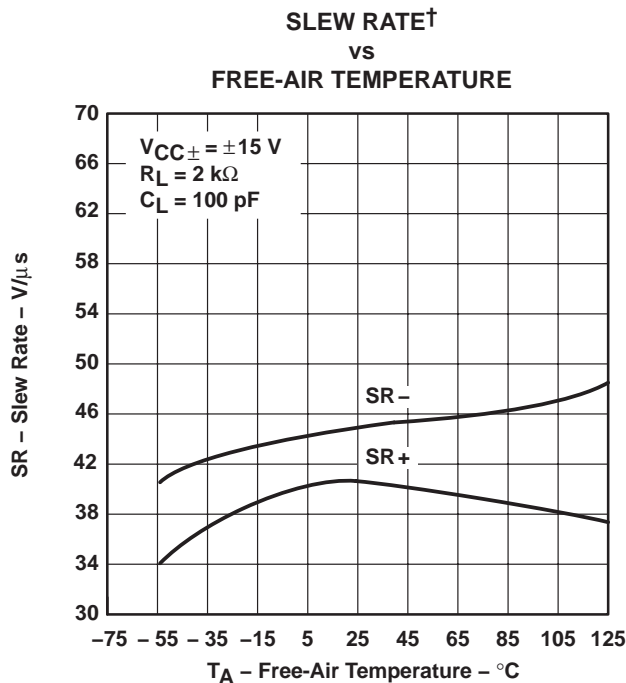

Figure 50

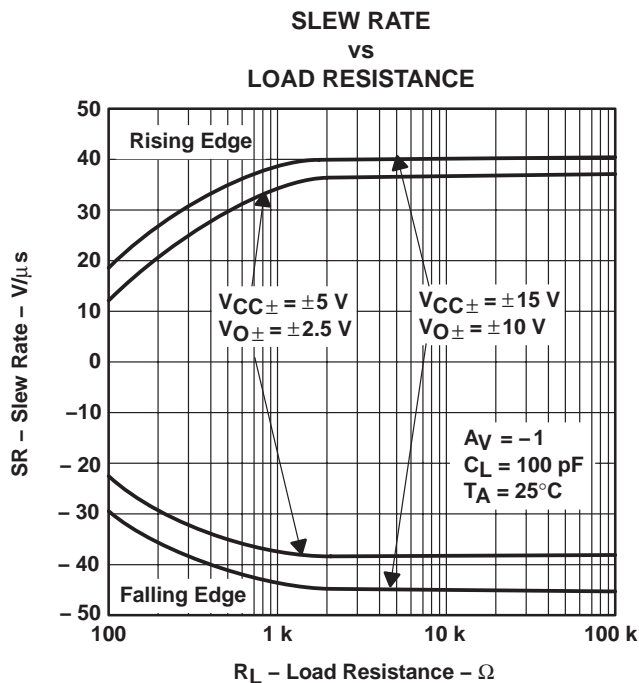

Figure 51

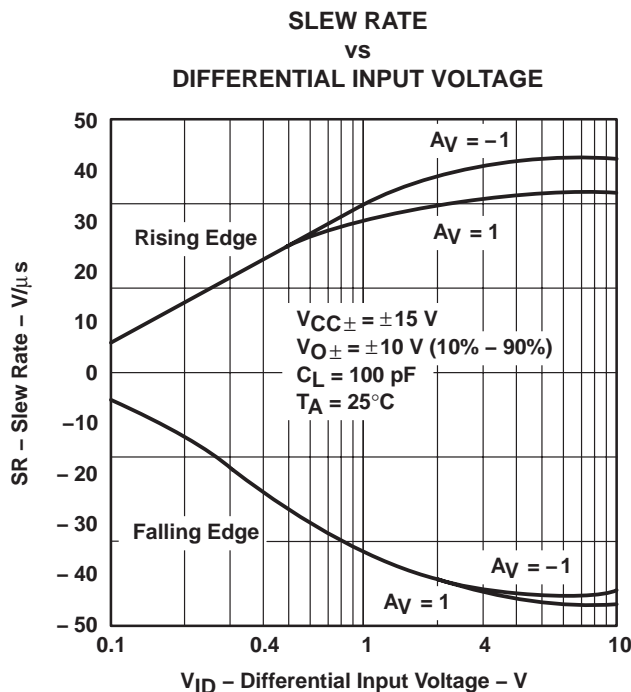

Figure 52

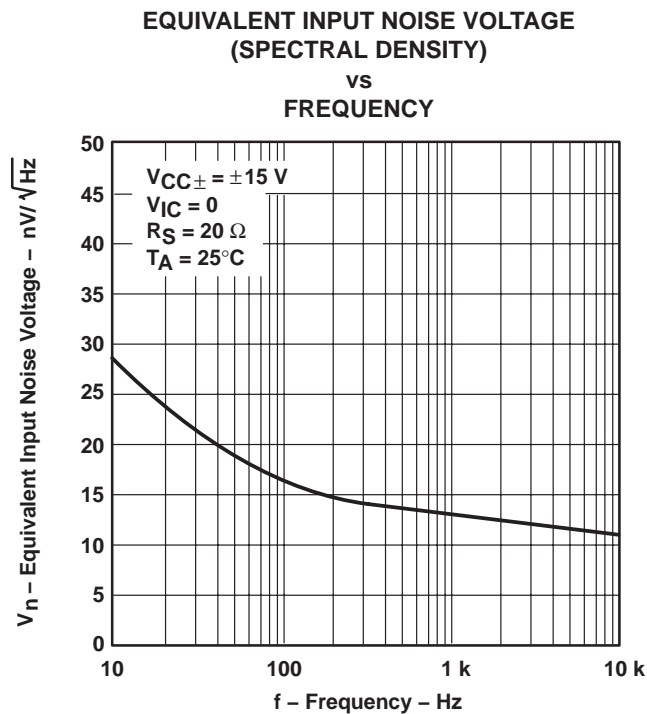

Figure 53

† Data at high and low temperatures are applicable only within the rated operating free-air temperature ranges of the various devices.

# TLE207x, TLE207xA EXCALIBUR LOW-NOISE HIGH-SPEED JFET-INPUT OPERATIONAL AMPLIFIERS

SLOS181B – FEBRUARY 1997 – REVISED APRIL 2004

## TYPICAL CHARACTERISTICS

INPUT-REFERRED NOISE VOLTAGE  
vs  
NOISE BANDWIDTH

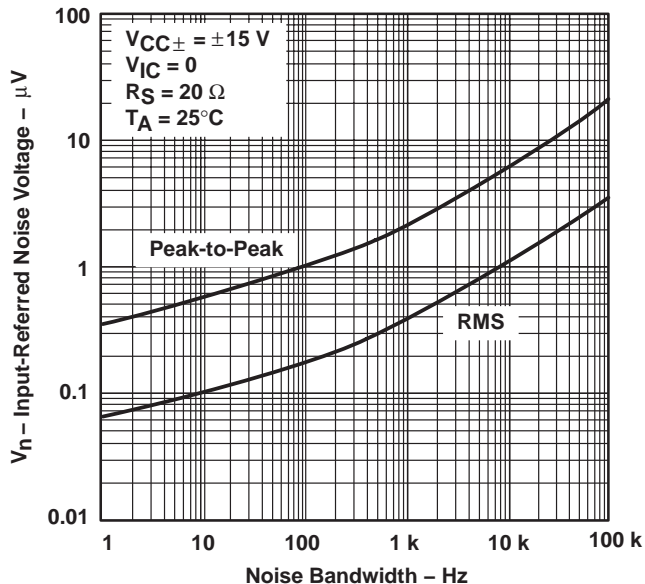

Figure 54

INPUT-REFERRED NOISE VOLTAGE  
OVER A 10-SECOND TIME INTERVAL

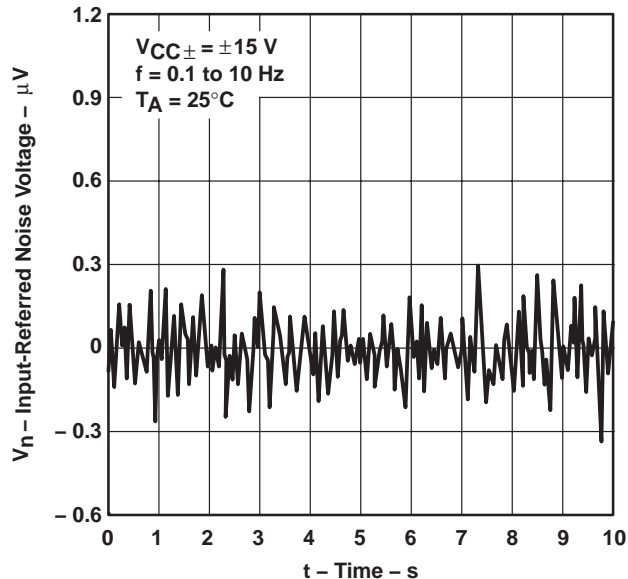

Figure 55

THIRD-OCTAVE SPECTRAL NOISE DENSITY  
vs  
FREQUENCY BANDS

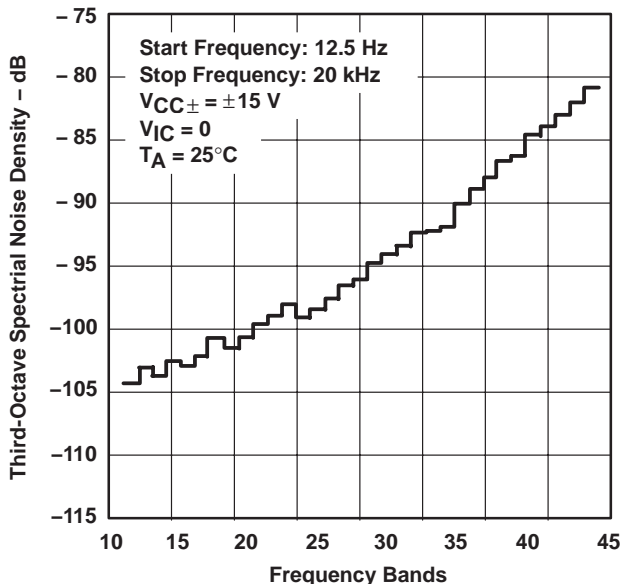

Figure 56

TOTAL HARMONIC DISTORTION PLUS NOISE  
vs  
FREQUENCY

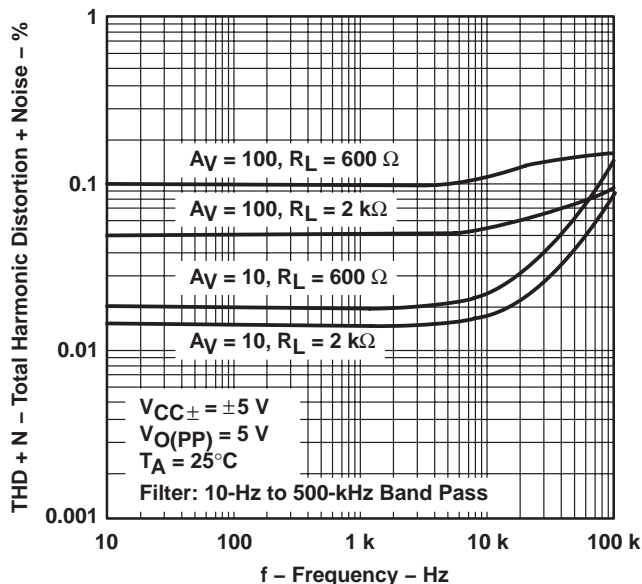
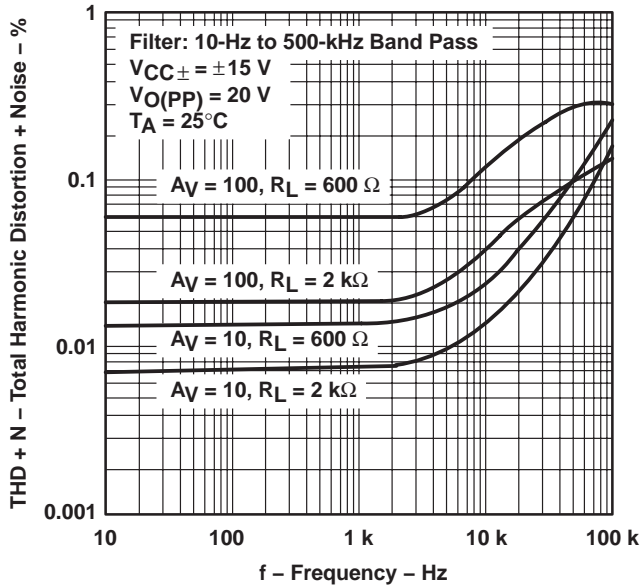

Figure 57

**TYPICAL CHARACTERISTICS**

**TOTAL HARMONIC DISTORTION PLUS NOISE  
 vs  
 FREQUENCY**



**Figure 58**

**UNITY-GAIN BANDWIDTH  
 vs  
 LOAD CAPACITANCE**

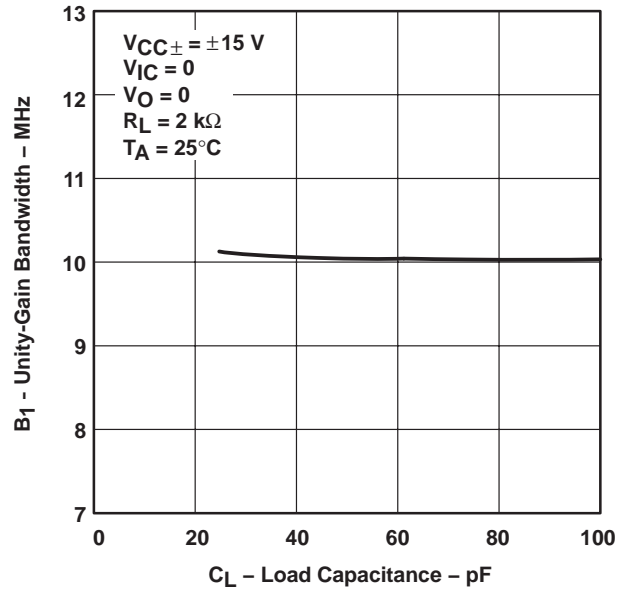

**Figure 59**

**GAIN-BANDWIDTH PRODUCT†  
 vs  
 FREE-AIR TEMPERATURE**

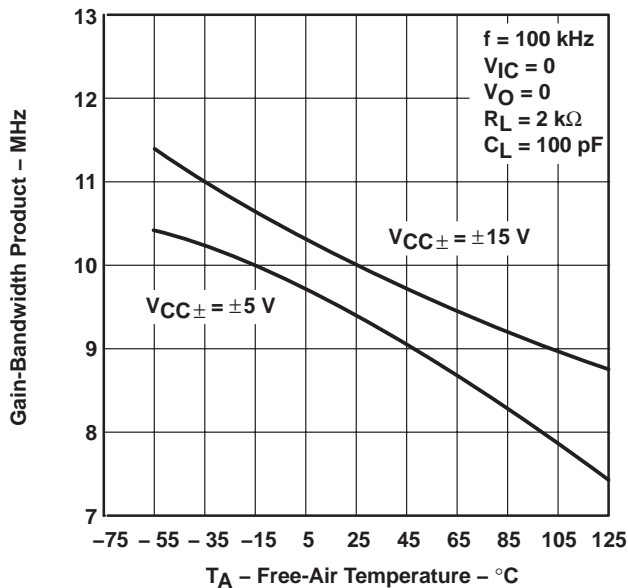

**Figure 60**

**GAIN-BANDWIDTH PRODUCT  
 vs  
 SUPPLY VOLTAGE**

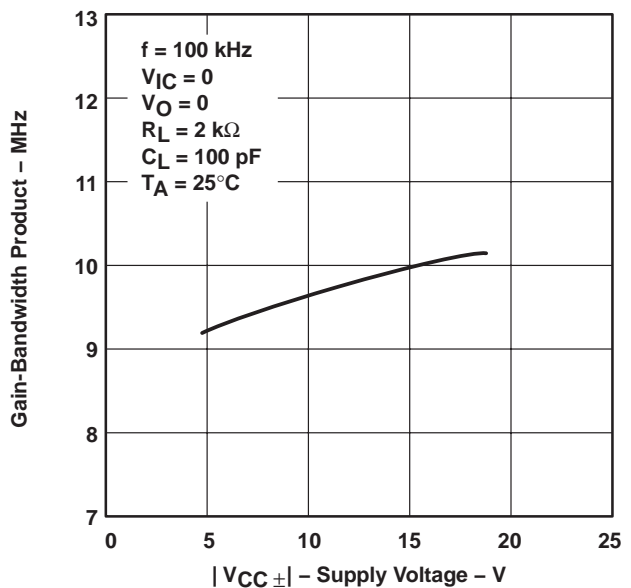

**Figure 61**

† Data at high and low temperatures are applicable only within the rated operating free-air temperature ranges of the various devices.

# TLE207x, TLE207xA EXCALIBUR LOW-NOISE HIGH-SPEED JFET-INPUT OPERATIONAL AMPLIFIERS

SLOS181B – FEBRUARY 1997 – REVISED APRIL 2004

## TYPICAL CHARACTERISTICS

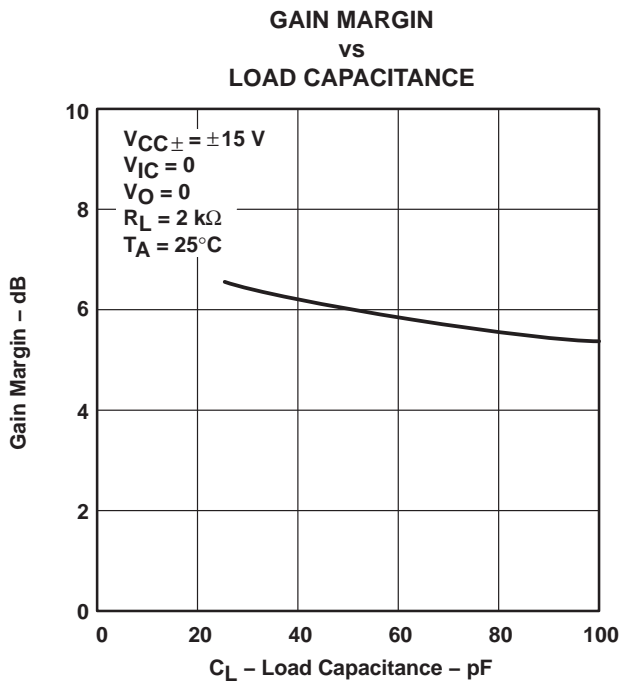

Figure 62

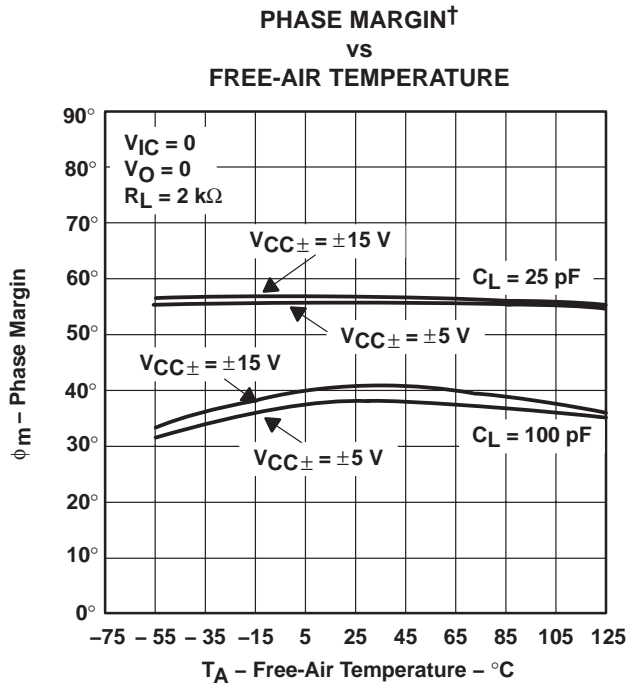

Figure 63

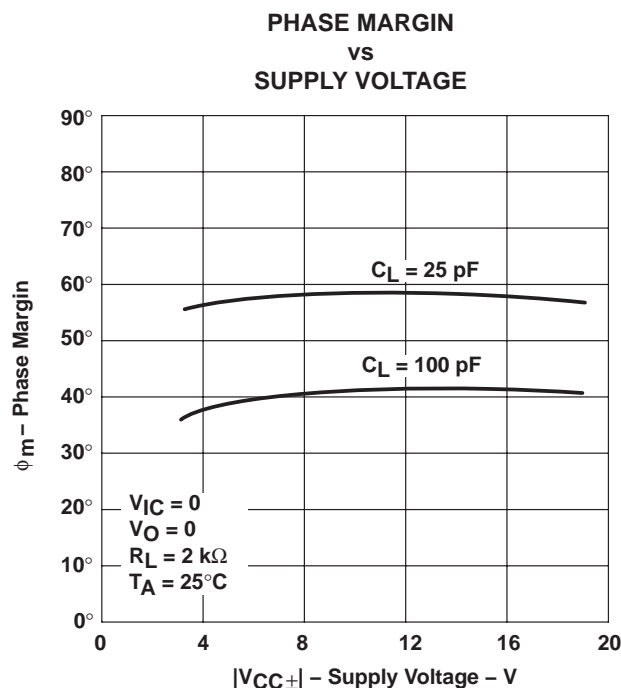

Figure 64

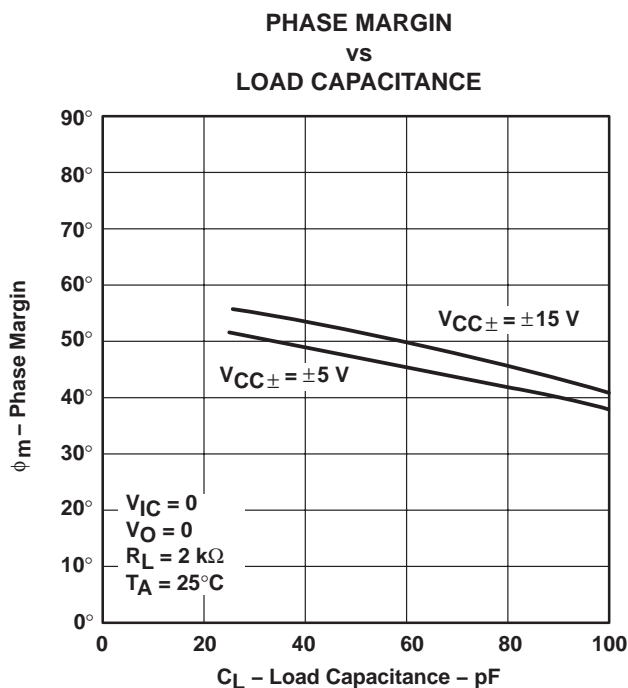

Figure 65

† Data at high and low temperatures are applicable only within the rated operating free-air temperature ranges of the various devices.



TYPICAL CHARACTERISTICS

NONINVERTING LARGE-SIGNAL  
 PULSE RESPONSE†

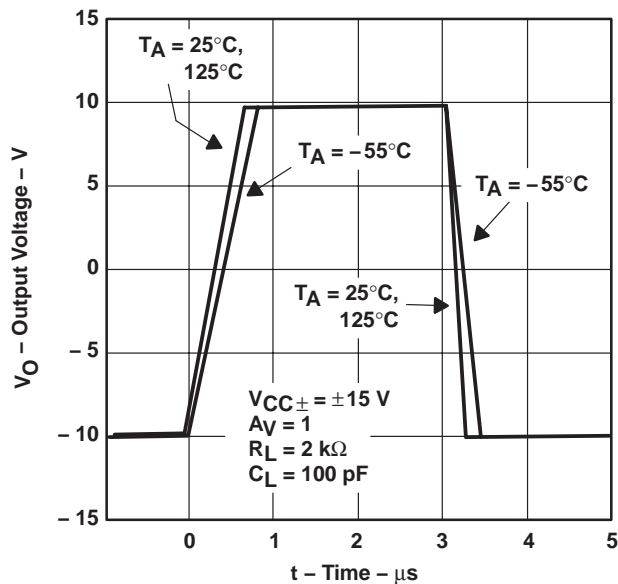

Figure 66

SMALL-SIGNAL PULSE RESPONSE

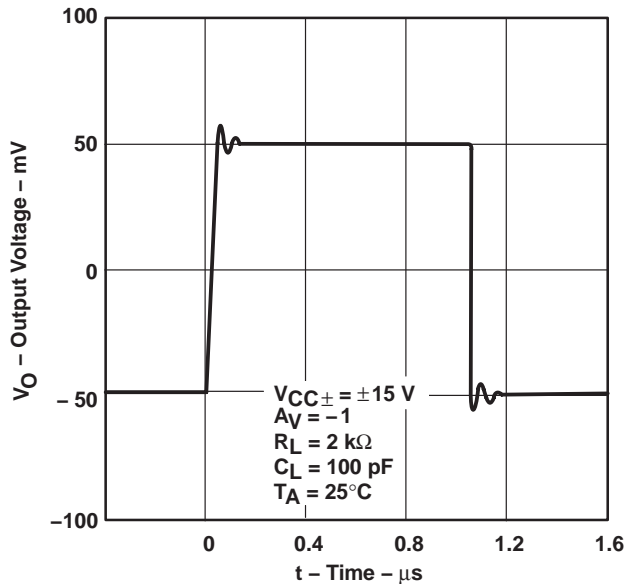

Figure 67

CLOSED-LOOP OUTPUT IMPEDANCE  
 vs  
 FREQUENCY

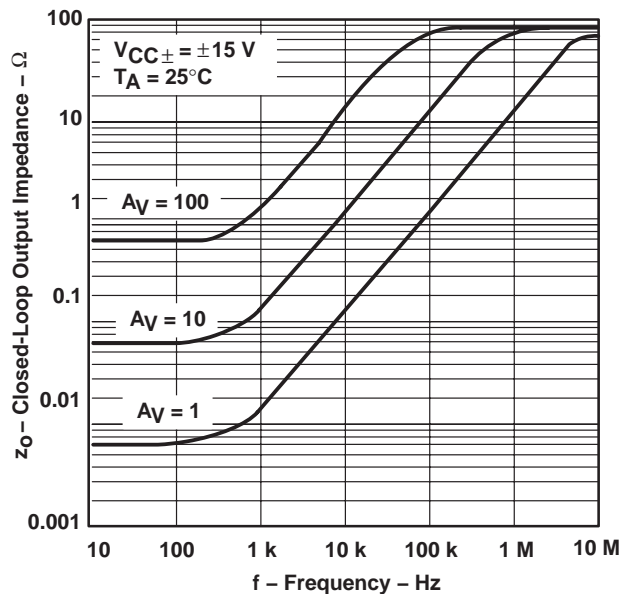

Figure 68

TLE2072 AND TLE2074  
 CROSSTALK ATTENUATION  
 vs  
 FREQUENCY

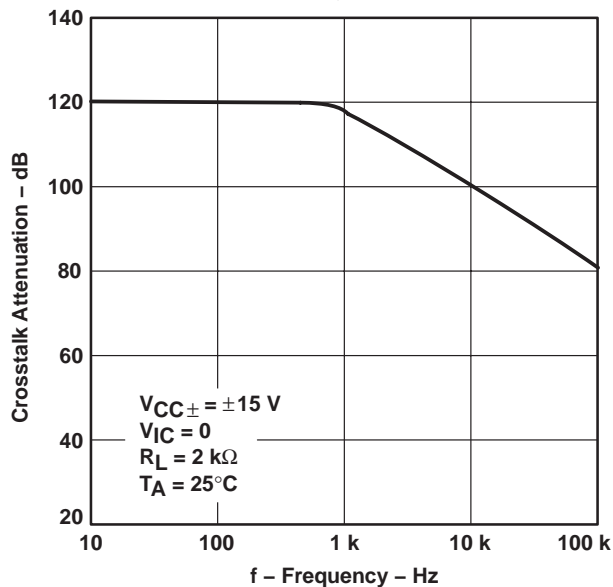

Figure 69

† Data at high and low temperatures are applicable only within the rated operating free-air temperature ranges of the various devices.

# TLE207x, TLE207xA EXCALIBUR LOW-NOISE HIGH-SPEED JFET-INPUT OPERATIONAL AMPLIFIERS

SLOS181B – FEBRUARY 1997 – REVISED APRIL 2004

## APPLICATION INFORMATION

### input characteristics

The TLE207x, TLE207xA, and TLE207xB are specified with a minimum and a maximum input voltage that if exceeded at either input could cause the device to malfunction. Because of the extremely high input impedance and resulting low bias current requirements, the TLE207x, TLE207xA, and TLE207xB are well suited for low-level signal processing; however, leakage currents on printed-circuit boards and sockets can easily exceed bias current requirements and cause degradation in system performance. It is good practice to include guard rings around inputs (see Figure 70). These guards should be driven from a low-impedance source at the same voltage level as the common-mode input.

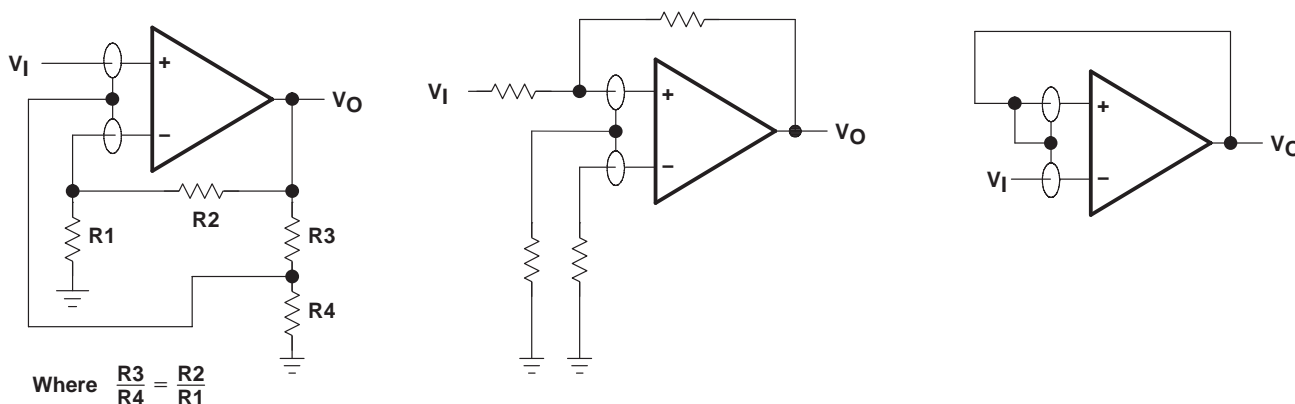

Figure 70. Use of Guard Rings

### TLE2071 input offset voltage nulling

The TLE2071 series offers external null pins that can be used to further reduce the input offset voltage. The circuit of Figure 71 can be connected as shown if the feature is desired. When external nulling is not needed, the null pins may be left unconnected.

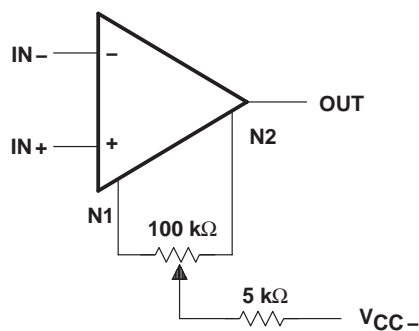

Figure 71. Input Offset Voltage Nulling

**APPLICATION INFORMATION**

**macromodel information**

Macromodel information provided was derived using *PSpice™ Parts™* model generation software. The Boyle macromodel (see Note 4) and subcircuit Figure 72 were generated using the TLE207x typical electrical and operating characteristics at  $T_A = 25^\circ\text{C}$ . Using this information, output simulations of the following key parameters can be generated to a tolerance of 20% (in most cases):

- Maximum positive output voltage swing
- Maximum negative output voltage swing
- Slew rate
- Quiescent power dissipation
- Input bias current
- Open-loop voltage amplification
- Unity-gain frequency
- Common-mode rejection ratio
- Phase margin
- DC output resistance
- AC output resistance
- Short-circuit output current limit

NOTE 4: G.R. Boyle, B.M. Cohn, D. O. Pederson, and J. E. Solomon, "Macromodeling of Integrated Circuit Operational Amplifiers", *IEEE Journal of Solid-State Circuits*, SC-9, 353 (1974).

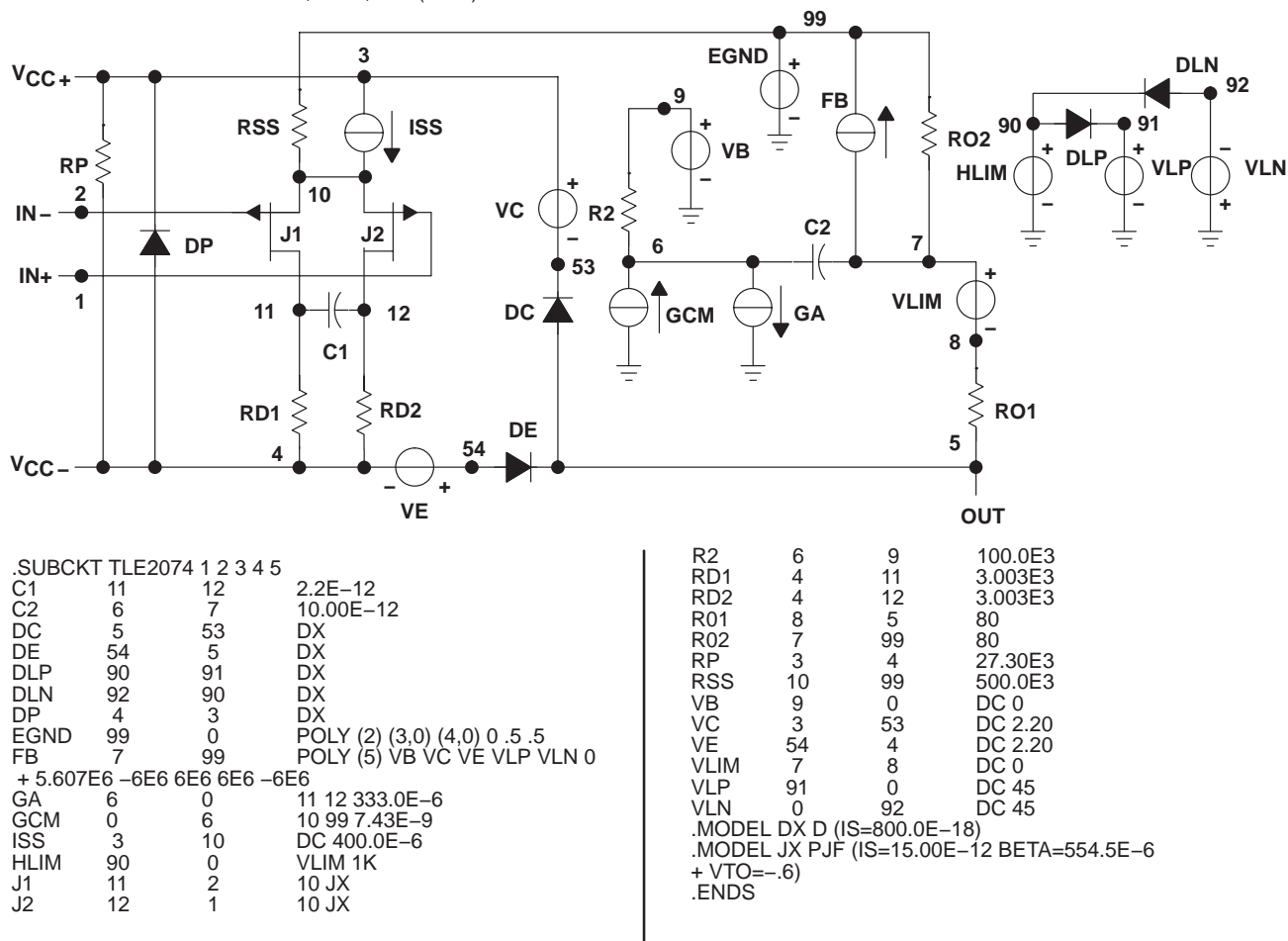

**Figure 72. Boyle Macromodel and Subcircuit**

*PSpice* and *Parts* are trademarks of MicroSim Corporation.

**PACKAGING INFORMATION**

Orderable Device	Status <sup>(1)</sup>	Package Type	Package Drawing	Pins	Package Qty	Eco Plan <sup>(2)</sup>	Lead/Ball Finish	MSL Peak Temp <sup>(3)</sup>
5962-9460201Q2A	ACTIVE	LCCC	FK	20	1	TBD	POST-PLATE	N / A for Pkg Type
5962-9460201QHA	ACTIVE	CFP	U	10	1	TBD	A42 SNPB	N / A for Pkg Type
5962-9460201QPA	ACTIVE	CDIP	JG	8	1	TBD	A42 SNPB	N / A for Pkg Type
5962-9460202Q2A	ACTIVE	LCCC	FK	20	1	TBD	POST-PLATE	N / A for Pkg Type
5962-9460202QHA	ACTIVE	CFP	U	10	1	TBD	A42 SNPB	N / A for Pkg Type
5962-9460202QPA	ACTIVE	CDIP	JG	8	1	TBD	A42 SNPB	N / A for Pkg Type
5962-9460203Q2A	ACTIVE	LCCC	FK	20	1	TBD	POST-PLATE	N / A for Pkg Type
5962-9460203QCA	ACTIVE	CDIP	J	14	1	TBD	A42 SNPB	N / A for Pkg Type
5962-9460203QDA	ACTIVE	CFP	W	14	1	TBD	A42 SNPB	N / A for Pkg Type
5962-9460204Q2A	ACTIVE	LCCC	FK	20	1	TBD	POST-PLATE	N / A for Pkg Type
5962-9460204QHA	ACTIVE	CFP	U	10	1	TBD	A42 SNPB	N / A for Pkg Type
5962-9460204QPA	ACTIVE	CDIP	JG	8	1	TBD	A42 SNPB	N / A for Pkg Type
5962-9460205Q2A	ACTIVE	LCCC	FK	20	1	TBD	POST-PLATE	N / A for Pkg Type
5962-9460205QHA	ACTIVE	CFP	U	10	1	TBD	A42 SNPB	N / A for Pkg Type
5962-9460205QPA	ACTIVE	CDIP	JG	8	1	TBD	A42 SNPB	N / A for Pkg Type
5962-9460206Q2A	ACTIVE	LCCC	FK	20	1	TBD	POST-PLATE	N / A for Pkg Type
5962-9460206QCA	ACTIVE	CDIP	J	14	1	TBD	A42 SNPB	N / A for Pkg Type
5962-9460206QDA	ACTIVE	CFP	W	14	1	TBD	A42 SNPB	N / A for Pkg Type
TLE2071ACD	ACTIVE	SOIC	D	8	75	Green (RoHS & no Sb/Br)	CU NIPDAU	Level-1-260C-UNLIM
TLE2071ACDG4	ACTIVE	SOIC	D	8	75	Green (RoHS & no Sb/Br)	CU NIPDAU	Level-1-260C-UNLIM
TLE2071ACDR	ACTIVE	SOIC	D	8	2500	Green (RoHS & no Sb/Br)	CU NIPDAU	Level-1-260C-UNLIM
TLE2071ACDRG4	ACTIVE	SOIC	D	8	2500	Green (RoHS & no Sb/Br)	CU NIPDAU	Level-1-260C-UNLIM
TLE2071ACP	ACTIVE	PDIP	P	8	50	Pb-Free (RoHS)	CU NIPDAU	N / A for Pkg Type
TLE2071ACPE4	ACTIVE	PDIP	P	8	50	Pb-Free (RoHS)	CU NIPDAU	N / A for Pkg Type
TLE2071AID	ACTIVE	SOIC	D	8	75	Green (RoHS & no Sb/Br)	CU NIPDAU	Level-1-260C-UNLIM
TLE2071AIDG4	ACTIVE	SOIC	D	8	75	Green (RoHS & no Sb/Br)	CU NIPDAU	Level-1-260C-UNLIM
TLE2071AIDR	ACTIVE	SOIC	D	8	2500	Green (RoHS & no Sb/Br)	CU NIPDAU	Level-1-260C-UNLIM
TLE2071AIDRG4	ACTIVE	SOIC	D	8	2500	Green (RoHS & no Sb/Br)	CU NIPDAU	Level-1-260C-UNLIM
TLE2071AIP	ACTIVE	PDIP	P	8	50	Pb-Free (RoHS)	CU NIPDAU	N / A for Pkg Type
TLE2071AIPE4	ACTIVE	PDIP	P	8	50	Pb-Free (RoHS)	CU NIPDAU	N / A for Pkg Type
TLE2071AMFKB	ACTIVE	LCCC	FK	20	1	TBD	POST-PLATE	N / A for Pkg Type
TLE2071AMJG	ACTIVE	CDIP	JG	8	1	TBD	A42 SNPB	N / A for Pkg Type
TLE2071AMJGB	ACTIVE	CDIP	JG	8	1	TBD	A42 SNPB	N / A for Pkg Type
TLE2071AMUB	ACTIVE	CFP	U	10	1	TBD	A42 SNPB	N / A for Pkg Type

Orderable Device	Status <sup>(1)</sup>	Package Type	Package Drawing	Pins	Package Qty	Eco Plan <sup>(2)</sup>	Lead/Ball Finish	MSL Peak Temp <sup>(3)</sup>
TLE2071CD	ACTIVE	SOIC	D	8	75	Green (RoHS & no Sb/Br)	CU NIPDAU	Level-1-260C-UNLIM
TLE2071CDG4	ACTIVE	SOIC	D	8	75	Green (RoHS & no Sb/Br)	CU NIPDAU	Level-1-260C-UNLIM
TLE2071CDR	OBSOLETE	SOIC	D	8		TBD	Call TI	Call TI
TLE2071CP	ACTIVE	PDIP	P	8	50	Pb-Free (RoHS)	CU NIPDAU	N / A for Pkg Type
TLE2071CPE4	ACTIVE	PDIP	P	8	50	Pb-Free (RoHS)	CU NIPDAU	N / A for Pkg Type
TLE2071ID	ACTIVE	SOIC	D	8	75	Green (RoHS & no Sb/Br)	CU NIPDAU	Level-1-260C-UNLIM
TLE2071IDG4	ACTIVE	SOIC	D	8	75	Green (RoHS & no Sb/Br)	CU NIPDAU	Level-1-260C-UNLIM
TLE2071IDR	ACTIVE	SOIC	D	8	2500	Green (RoHS & no Sb/Br)	CU NIPDAU	Level-1-260C-UNLIM
TLE2071IDRG4	ACTIVE	SOIC	D	8	2500	Green (RoHS & no Sb/Br)	CU NIPDAU	Level-1-260C-UNLIM
TLE2071IP	ACTIVE	PDIP	P	8	50	Pb-Free (RoHS)	CU NIPDAU	N / A for Pkg Type
TLE2071IPE4	ACTIVE	PDIP	P	8	50	Pb-Free (RoHS)	CU NIPDAU	N / A for Pkg Type
TLE2071MFKB	ACTIVE	LCCC	FK	20	1	TBD	POST-PLATE	N / A for Pkg Type
TLE2071MJG	ACTIVE	CDIP	JG	8	1	TBD	A42 SNPB	N / A for Pkg Type
TLE2071MJGB	ACTIVE	CDIP	JG	8	1	TBD	A42 SNPB	N / A for Pkg Type
TLE2071MUB	ACTIVE	CFP	U	10	1	TBD	A42 SNPB	N / A for Pkg Type
TLE2072ACD	ACTIVE	SOIC	D	8	75	Green (RoHS & no Sb/Br)	CU NIPDAU	Level-1-260C-UNLIM
TLE2072ACDG4	ACTIVE	SOIC	D	8	75	Green (RoHS & no Sb/Br)	CU NIPDAU	Level-1-260C-UNLIM
TLE2072ACP	ACTIVE	PDIP	P	8	50	Pb-Free (RoHS)	CU NIPDAU	N / A for Pkg Type
TLE2072ACPE4	ACTIVE	PDIP	P	8	50	Pb-Free (RoHS)	CU NIPDAU	N / A for Pkg Type
TLE2072AID	ACTIVE	SOIC	D	8	75	Green (RoHS & no Sb/Br)	CU NIPDAU	Level-1-260C-UNLIM
TLE2072AIDG4	ACTIVE	SOIC	D	8	75	Green (RoHS & no Sb/Br)	CU NIPDAU	Level-1-260C-UNLIM
TLE2072AIDR	ACTIVE	SOIC	D	8	2500	Green (RoHS & no Sb/Br)	CU NIPDAU	Level-1-260C-UNLIM
TLE2072AIDRG4	ACTIVE	SOIC	D	8	2500	Green (RoHS & no Sb/Br)	CU NIPDAU	Level-1-260C-UNLIM
TLE2072AIP	ACTIVE	PDIP	P	8	50	Pb-Free (RoHS)	CU NIPDAU	N / A for Pkg Type
TLE2072AIPE4	ACTIVE	PDIP	P	8	50	Pb-Free (RoHS)	CU NIPDAU	N / A for Pkg Type
TLE2072AMFKB	ACTIVE	LCCC	FK	20	1	TBD	POST-PLATE	N / A for Pkg Type
TLE2072AMJG	ACTIVE	CDIP	JG	8	1	TBD	A42 SNPB	N / A for Pkg Type
TLE2072AMJGB	ACTIVE	CDIP	JG	8	1	TBD	A42 SNPB	N / A for Pkg Type
TLE2072AMUB	ACTIVE	CFP	U	10	1	TBD	A42 SNPB	N / A for Pkg Type
TLE2072CD	ACTIVE	SOIC	D	8	75	Green (RoHS & no Sb/Br)	CU NIPDAU	Level-1-260C-UNLIM

Orderable Device	Status <sup>(1)</sup>	Package Type	Package Drawing	Pins	Package Qty	Eco Plan <sup>(2)</sup>	Lead/Ball Finish	MSL Peak Temp <sup>(3)</sup>
						no Sb/Br)		
TLE2072CDG4	ACTIVE	SOIC	D	8	75	Green (RoHS & no Sb/Br)	CU NIPDAU	Level-1-260C-UNLIM
TLE2072CDR	ACTIVE	SOIC	D	8	2500	Green (RoHS & no Sb/Br)	CU NIPDAU	Level-1-260C-UNLIM
TLE2072CDRG4	ACTIVE	SOIC	D	8	2500	Green (RoHS & no Sb/Br)	CU NIPDAU	Level-1-260C-UNLIM
TLE2072CP	ACTIVE	PDIP	P	8	50	Pb-Free (RoHS)	CU NIPDAU	N / A for Pkg Type
TLE2072CPE4	ACTIVE	PDIP	P	8	50	Pb-Free (RoHS)	CU NIPDAU	N / A for Pkg Type
TLE2072ID	ACTIVE	SOIC	D	8	75	Green (RoHS & no Sb/Br)	CU NIPDAU	Level-1-260C-UNLIM
TLE2072IDG4	ACTIVE	SOIC	D	8	75	Green (RoHS & no Sb/Br)	CU NIPDAU	Level-1-260C-UNLIM
TLE2072IDR	ACTIVE	SOIC	D	8	2500	Green (RoHS & no Sb/Br)	CU NIPDAU	Level-1-260C-UNLIM
TLE2072IDRG4	ACTIVE	SOIC	D	8	2500	Green (RoHS & no Sb/Br)	CU NIPDAU	Level-1-260C-UNLIM
TLE2072IP	ACTIVE	PDIP	P	8	50	Pb-Free (RoHS)	CU NIPDAU	N / A for Pkg Type
TLE2072IPE4	ACTIVE	PDIP	P	8	50	Pb-Free (RoHS)	CU NIPDAU	N / A for Pkg Type
TLE2072MFKB	ACTIVE	LCCC	FK	20	1	TBD	POST-PLATE	N / A for Pkg Type
TLE2072MJG	ACTIVE	CDIP	JG	8	1	TBD	A42 SNPB	N / A for Pkg Type
TLE2072MJGB	ACTIVE	CDIP	JG	8	1	TBD	A42 SNPB	N / A for Pkg Type
TLE2072MUB	ACTIVE	CFP	U	10	1	TBD	A42 SNPB	N / A for Pkg Type
TLE2074ACDW	ACTIVE	SOIC	DW	16	40	Green (RoHS & no Sb/Br)	CU NIPDAU	Level-1-260C-UNLIM
TLE2074ACDWG4	ACTIVE	SOIC	DW	16	40	Green (RoHS & no Sb/Br)	CU NIPDAU	Level-1-260C-UNLIM
TLE2074ACDWR	OBSOLETE	SOIC	DW	16		TBD	Call TI	Call TI
TLE2074ACN	ACTIVE	PDIP	N	14	25	Pb-Free (RoHS)	CU NIPDAU	N / A for Pkg Type
TLE2074ACNE4	ACTIVE	PDIP	N	14	25	Pb-Free (RoHS)	CU NIPDAU	N / A for Pkg Type
TLE2074AIDW	ACTIVE	SOIC	DW	16	40	Green (RoHS & no Sb/Br)	CU NIPDAU	Level-1-260C-UNLIM
TLE2074AIDWG4	ACTIVE	SOIC	DW	16	40	Green (RoHS & no Sb/Br)	CU NIPDAU	Level-1-260C-UNLIM
TLE2074AIDWR	OBSOLETE	SOIC	DW	16		TBD	Call TI	Call TI
TLE2074AIN	ACTIVE	PDIP	N	14	25	Pb-Free (RoHS)	CU NIPDAU	N / A for Pkg Type
TLE2074AINE4	ACTIVE	PDIP	N	14	25	Pb-Free (RoHS)	CU NIPDAU	N / A for Pkg Type
TLE2074AMFKB	ACTIVE	LCCC	FK	20	1	TBD	POST-PLATE	N / A for Pkg Type
TLE2074AMJ	ACTIVE	CDIP	J	14	1	TBD	A42 SNPB	N / A for Pkg Type
TLE2074AMJB	ACTIVE	CDIP	J	14	1	TBD	A42 SNPB	N / A for Pkg Type
TLE2074AMWB	ACTIVE	CFP	W	14	1	TBD	A42 SNPB	N / A for Pkg Type

Orderable Device	Status <sup>(1)</sup>	Package Type	Package Drawing	Pins	Package Qty	Eco Plan <sup>(2)</sup>	Lead/Ball Finish	MSL Peak Temp <sup>(3)</sup>
TLE2074CDW	ACTIVE	SOIC	DW	16	40	Green (RoHS & no Sb/Br)	CU NIPDAU	Level-1-260C-UNLIM
TLE2074CDWG4	ACTIVE	SOIC	DW	16	40	Green (RoHS & no Sb/Br)	CU NIPDAU	Level-1-260C-UNLIM
TLE2074CDWR	ACTIVE	SOIC	DW	16	2000	Green (RoHS & no Sb/Br)	CU NIPDAU	Level-1-260C-UNLIM
TLE2074CDWRG4	ACTIVE	SOIC	DW	16	2000	Green (RoHS & no Sb/Br)	CU NIPDAU	Level-1-260C-UNLIM
TLE2074CN	ACTIVE	PDIP	N	14	25	Pb-Free (RoHS)	CU NIPDAU	N / A for Pkg Type
TLE2074CNE4	ACTIVE	PDIP	N	14	25	Pb-Free (RoHS)	CU NIPDAU	N / A for Pkg Type
TLE2074IDW	ACTIVE	SOIC	DW	16	40	Green (RoHS & no Sb/Br)	CU NIPDAU	Level-1-260C-UNLIM
TLE2074IDWG4	ACTIVE	SOIC	DW	16	40	Green (RoHS & no Sb/Br)	CU NIPDAU	Level-1-260C-UNLIM
TLE2074IDWR	OBSOLETE	SOIC	DW	16		TBD	Call TI	Call TI
TLE2074IN	ACTIVE	PDIP	N	14	25	Pb-Free (RoHS)	CU NIPDAU	N / A for Pkg Type
TLE2074INE4	ACTIVE	PDIP	N	14	25	Pb-Free (RoHS)	CU NIPDAU	N / A for Pkg Type
TLE2074MFKB	ACTIVE	LCCC	FK	20	1	TBD	POST-PLATE	N / A for Pkg Type
TLE2074MJ	ACTIVE	CDIP	J	14	1	TBD	A42 SNPB	N / A for Pkg Type
TLE2074MJB	ACTIVE	CDIP	J	14	1	TBD	A42 SNPB	N / A for Pkg Type
TLE2074MWB	ACTIVE	CFP	W	14	1	TBD	A42 SNPB	N / A for Pkg Type

<sup>(1)</sup> The marketing status values are defined as follows:

**ACTIVE:** Product device recommended for new designs.

**LIFEBUY:** TI has announced that the device will be discontinued, and a lifetime-buy period is in effect.

**NRND:** Not recommended for new designs. Device is in production to support existing customers, but TI does not recommend using this part in a new design.

**PREVIEW:** Device has been announced but is not in production. Samples may or may not be available.

**OBSOLETE:** TI has discontinued the production of the device.

<sup>(2)</sup> Eco Plan - The planned eco-friendly classification: Pb-Free (RoHS), Pb-Free (RoHS Exempt), or Green (RoHS & no Sb/Br) - please check <http://www.ti.com/productcontent> for the latest availability information and additional product content details.

**TBD:** The Pb-Free/Green conversion plan has not been defined.

**Pb-Free (RoHS):** TI's terms "Lead-Free" or "Pb-Free" mean semiconductor products that are compatible with the current RoHS requirements for all 6 substances, including the requirement that lead not exceed 0.1% by weight in homogeneous materials. Where designed to be soldered at high temperatures, TI Pb-Free products are suitable for use in specified lead-free processes.

**Pb-Free (RoHS Exempt):** This component has a RoHS exemption for either 1) lead-based flip-chip solder bumps used between the die and package, or 2) lead-based die adhesive used between the die and leadframe. The component is otherwise considered Pb-Free (RoHS compatible) as defined above.

**Green (RoHS & no Sb/Br):** TI defines "Green" to mean Pb-Free (RoHS compatible), and free of Bromine (Br) and Antimony (Sb) based flame retardants (Br or Sb do not exceed 0.1% by weight in homogeneous material)

<sup>(3)</sup> MSL, Peak Temp. -- The Moisture Sensitivity Level rating according to the JEDEC industry standard classifications, and peak solder temperature.

**Important Information and Disclaimer:** The information provided on this page represents TI's knowledge and belief as of the date that it is provided. TI bases its knowledge and belief on information provided by third parties, and makes no representation or warranty as to the accuracy of such information. Efforts are underway to better integrate information from third parties. TI has taken and continues to take reasonable steps to provide representative and accurate information but may not have conducted destructive testing or chemical analysis on incoming materials and chemicals. TI and TI suppliers consider certain information to be proprietary, and thus CAS numbers and other limited information may not be available for release.

In no event shall TI's liability arising out of such information exceed the total purchase price of the TI part(s) at issue in this document sold by TI to Customer on an annual basis.

**OTHER QUALIFIED VERSIONS OF TLE2071, TLE2071A, TLE2071AM, TLE2071M, TLE2072, TLE2072A, TLE2072AM, TLE2072M, TLE2074, TLE2074A, TLE2074AM, TLE2074M :**

- Automotive: [TLE2071-Q1](#), [TLE2071A-Q1](#), [TLE2072-Q1](#), [TLE2072A-Q1](#)

NOTE: Qualified Version Definitions:

- Automotive - Q100 devices qualified for high-reliability automotive applications targeting zero defects



**TAPE AND REEL INFORMATION**



**QUADRANT ASSIGNMENTS FOR PIN 1 ORIENTATION IN TAPE**



\*All dimensions are nominal

Device	Package Type	Package Drawing	Pins	SPQ	Reel Diameter (mm)	Reel Width W1 (mm)	A0 (mm)	B0 (mm)	K0 (mm)	P1 (mm)	W (mm)	Pin1 Quadrant
TLE2071ACDR	SOIC	D	8	2500	330.0	12.4	6.4	5.2	2.1	8.0	12.0	Q1
TLE2071AIDR	SOIC	D	8	2500	330.0	12.4	6.4	5.2	2.1	8.0	12.0	Q1
TLE2071IDR	SOIC	D	8	2500	330.0	12.4	6.4	5.2	2.1	8.0	12.0	Q1
TLE2072AIDR	SOIC	D	8	2500	330.0	12.4	6.4	5.2	2.1	8.0	12.0	Q1
TLE2072CDR	SOIC	D	8	2500	330.0	12.4	6.4	5.2	2.1	8.0	12.0	Q1
TLE2072IDR	SOIC	D	8	2500	330.0	12.4	6.4	5.2	2.1	8.0	12.0	Q1
TLE2074CDWR	SOIC	DW	16	2000	330.0	16.4	10.75	10.7	2.7	12.0	16.0	Q1

**TAPE AND REEL BOX DIMENSIONS**



\*All dimensions are nominal

Device	Package Type	Package Drawing	Pins	SPQ	Length (mm)	Width (mm)	Height (mm)
TLE2071ACDR	SOIC	D	8	2500	346.0	346.0	29.0
TLE2071AIDR	SOIC	D	8	2500	346.0	346.0	29.0
TLE2071IDR	SOIC	D	8	2500	346.0	346.0	29.0
TLE2072AIDR	SOIC	D	8	2500	346.0	346.0	29.0
TLE2072CDR	SOIC	D	8	2500	346.0	346.0	29.0
TLE2072IDR	SOIC	D	8	2500	346.0	346.0	29.0
TLE2074CDWR	SOIC	DW	16	2000	346.0	346.0	33.0

J (R-GDIP-T\*\*)

14 LEADS SHOWN

CERAMIC DUAL IN-LINE PACKAGE



DIM \ PINS **	14	16	18	20
A	0.300 (7,62) BSC	0.300 (7,62) BSC	0.300 (7,62) BSC	0.300 (7,62) BSC
B MAX	0.785 (19,94)	.840 (21,34)	0.960 (24,38)	1.060 (26,92)
B MIN	—	—	—	—
C MAX	0.300 (7,62)	0.300 (7,62)	0.310 (7,87)	0.300 (7,62)
C MIN	0.245 (6,22)	0.245 (6,22)	0.220 (5,59)	0.245 (6,22)



4040083/F 03/03

- NOTES:
- All linear dimensions are in inches (millimeters).
  - This drawing is subject to change without notice.
  - This package is hermetically sealed with a ceramic lid using glass frit.
  - Index point is provided on cap for terminal identification only on press ceramic glass frit seal only.
  - Falls within MIL STD 1835 GDIP1-T14, GDIP1-T16, GDIP1-T18 and GDIP1-T20.

FK (S-CQCC-N\*\*)

LEADLESS CERAMIC CHIP CARRIER

28 TERMINAL SHOWN



- NOTES:
- A. All linear dimensions are in inches (millimeters).
  - B. This drawing is subject to change without notice.
  - C. This package can be hermetically sealed with a metal lid.
  - D. The terminals are gold plated.
  - E. Falls within JEDEC MS-004

D (R-PDSO-G8)

PLASTIC SMALL-OUTLINE PACKAGE

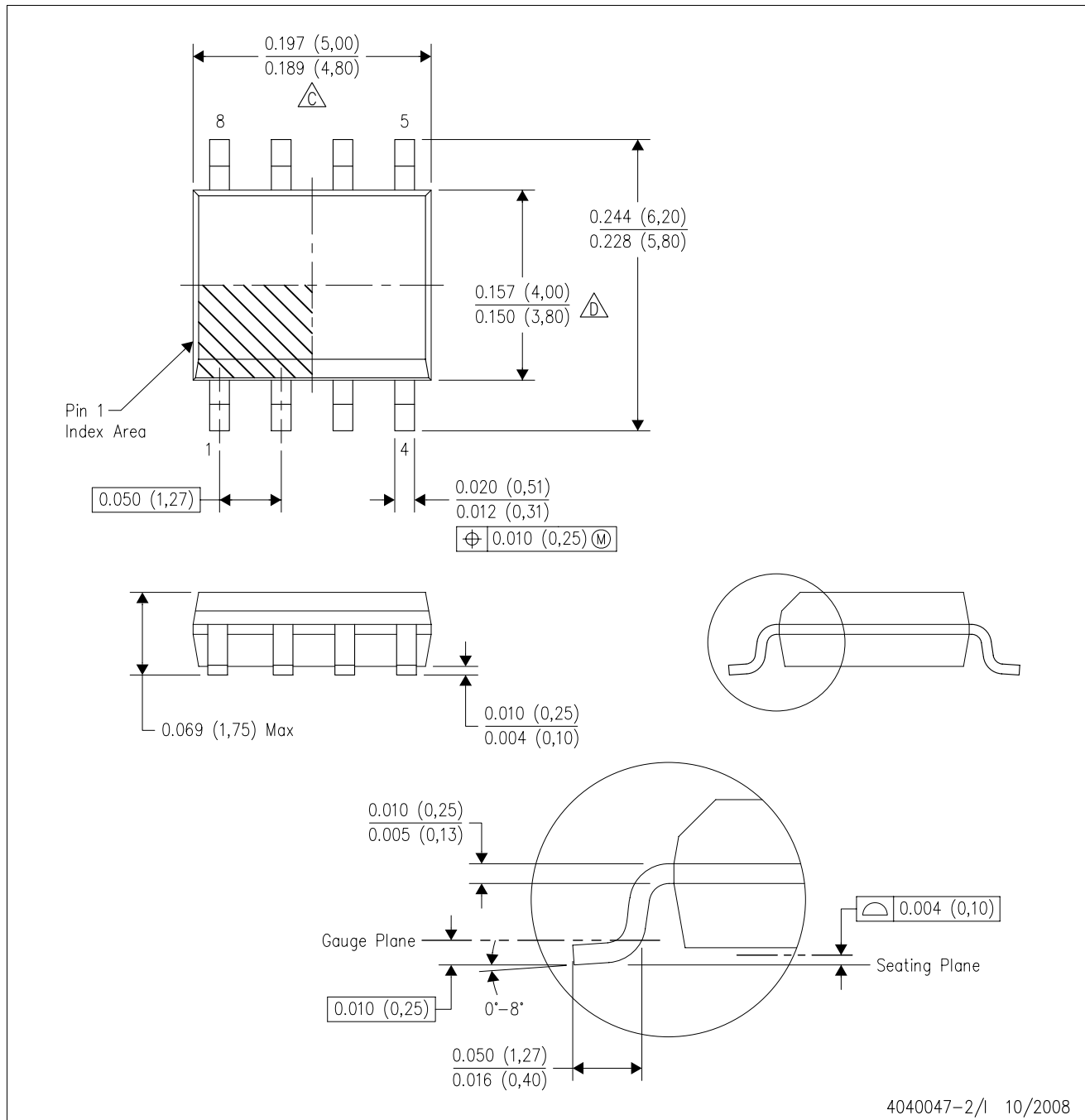

- NOTES:
- A. All linear dimensions are in inches (millimeters).
  - B. This drawing is subject to change without notice.
  - C. Body length does not include mold flash, protrusions, or gate burrs. Mold flash, protrusions, or gate burrs shall not exceed .006 (0,15) per end.
  - D. Body width does not include interlead flash. Interlead flash shall not exceed .017 (0,43) per side.
  - E. Reference JEDEC MS-012 variation AA.

W (R-GDFP-F14)

CERAMIC DUAL FLATPACK

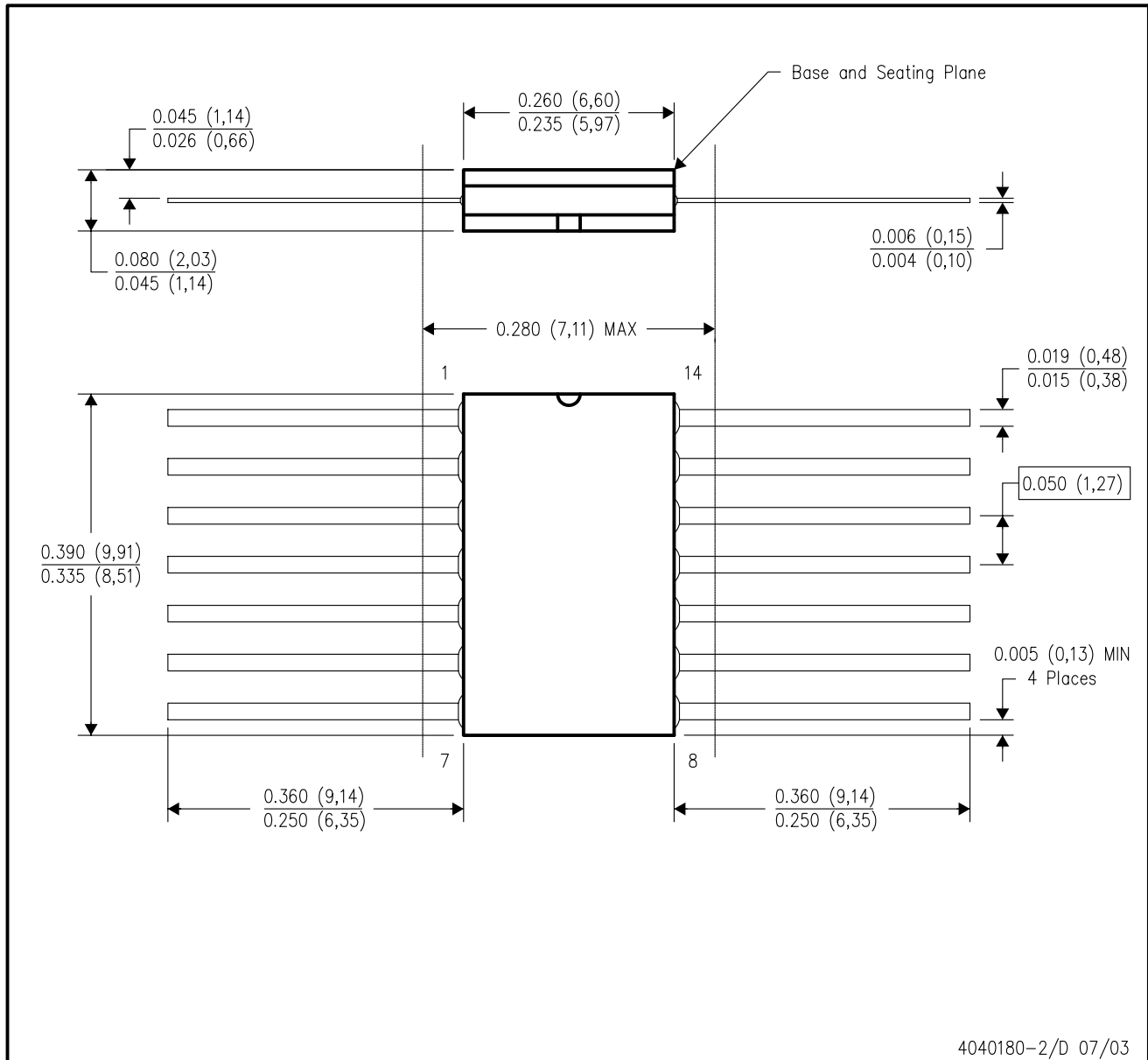

- NOTES:
- All linear dimensions are in inches (millimeters).
  - This drawing is subject to change without notice.
  - This package can be hermetically sealed with a ceramic lid using glass frit.
  - Index point is provided on cap for terminal identification only.
  - Falls within MIL STD 1835 GDFP1-F14 and JEDEC MO-092AB

DW (R-PDSO-G16)

PLASTIC SMALL-OUTLINE PACKAGE

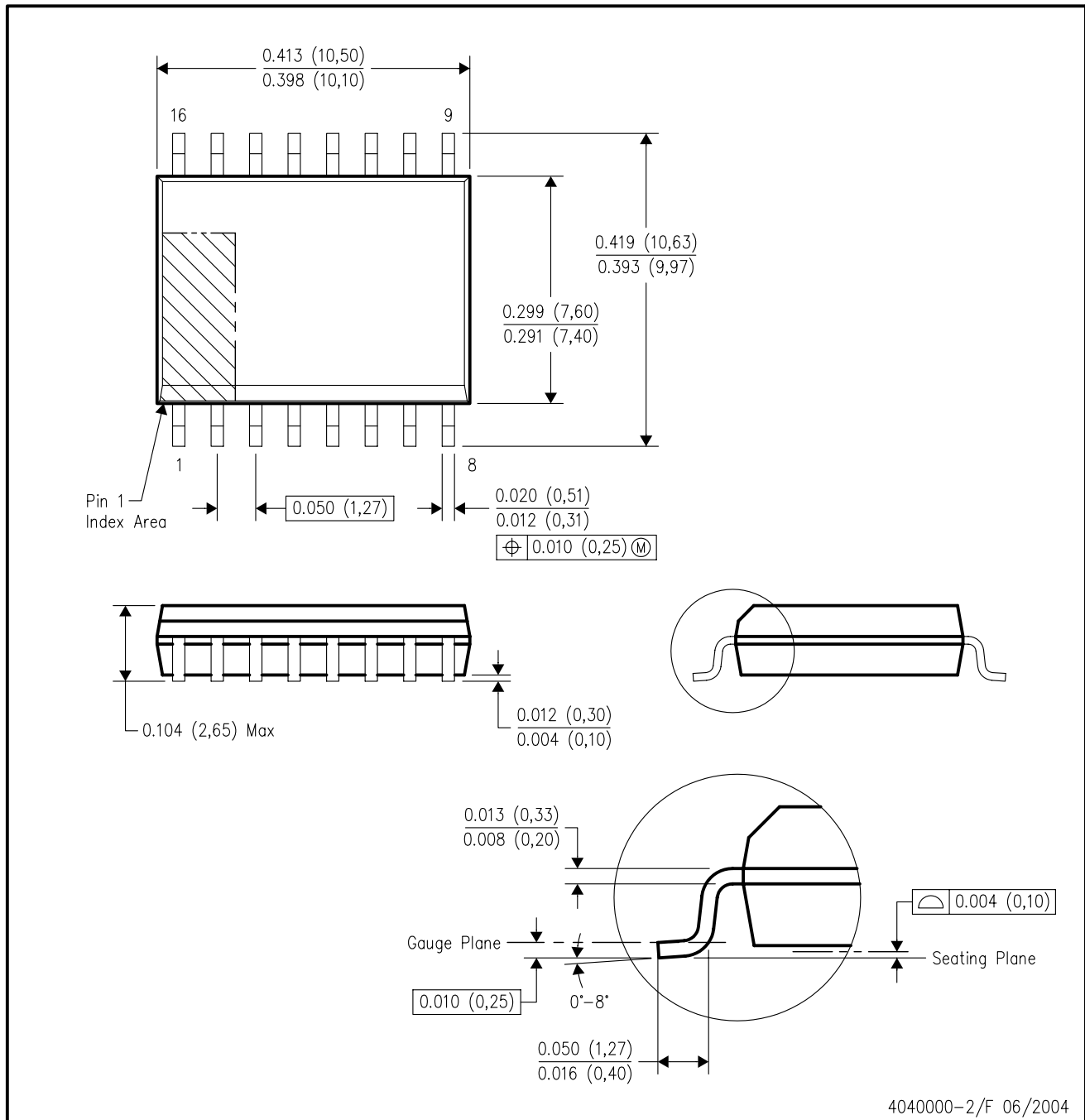

4040000-2/F 06/2004

- NOTES:
- A. All linear dimensions are in inches (millimeters).
  - B. This drawing is subject to change without notice.
  - C. Body dimensions do not include mold flash or protrusion not to exceed 0.006 (0,15).
  - D. Falls within JEDEC MS-013 variation AA.

JG (R-GDIP-T8)

CERAMIC DUAL-IN-LINE



- NOTES: A. All linear dimensions are in inches (millimeters).  
 B. This drawing is subject to change without notice.  
 C. This package can be hermetically sealed with a ceramic lid using glass frit.  
 D. Index point is provided on cap for terminal identification.  
 E. Falls within MIL STD 1835 GDIP1-T8



P (R-PDIP-T8)

PLASTIC DUAL-IN-LINE



- NOTES: A. All linear dimensions are in inches (millimeters).  
 B. This drawing is subject to change without notice.  
 C. Falls within JEDEC MS-001

For the latest package information, go to [http://www.ti.com/sc/docs/package/pkg\\_info.htm](http://www.ti.com/sc/docs/package/pkg_info.htm)



N (R-PDIP-T\*\*)

PLASTIC DUAL-IN-LINE PACKAGE

16 PINS SHOWN



- NOTES:
- A. All linear dimensions are in inches (millimeters).
  - B. This drawing is subject to change without notice.
  - Falls within JEDEC MS-001, except 18 and 20 pin minimum body length (Dim A).
  - The 20 pin end lead shoulder width is a vendor option, either half or full width.

U (S-GDFP-F10)

CERAMIC DUAL FLATPACK

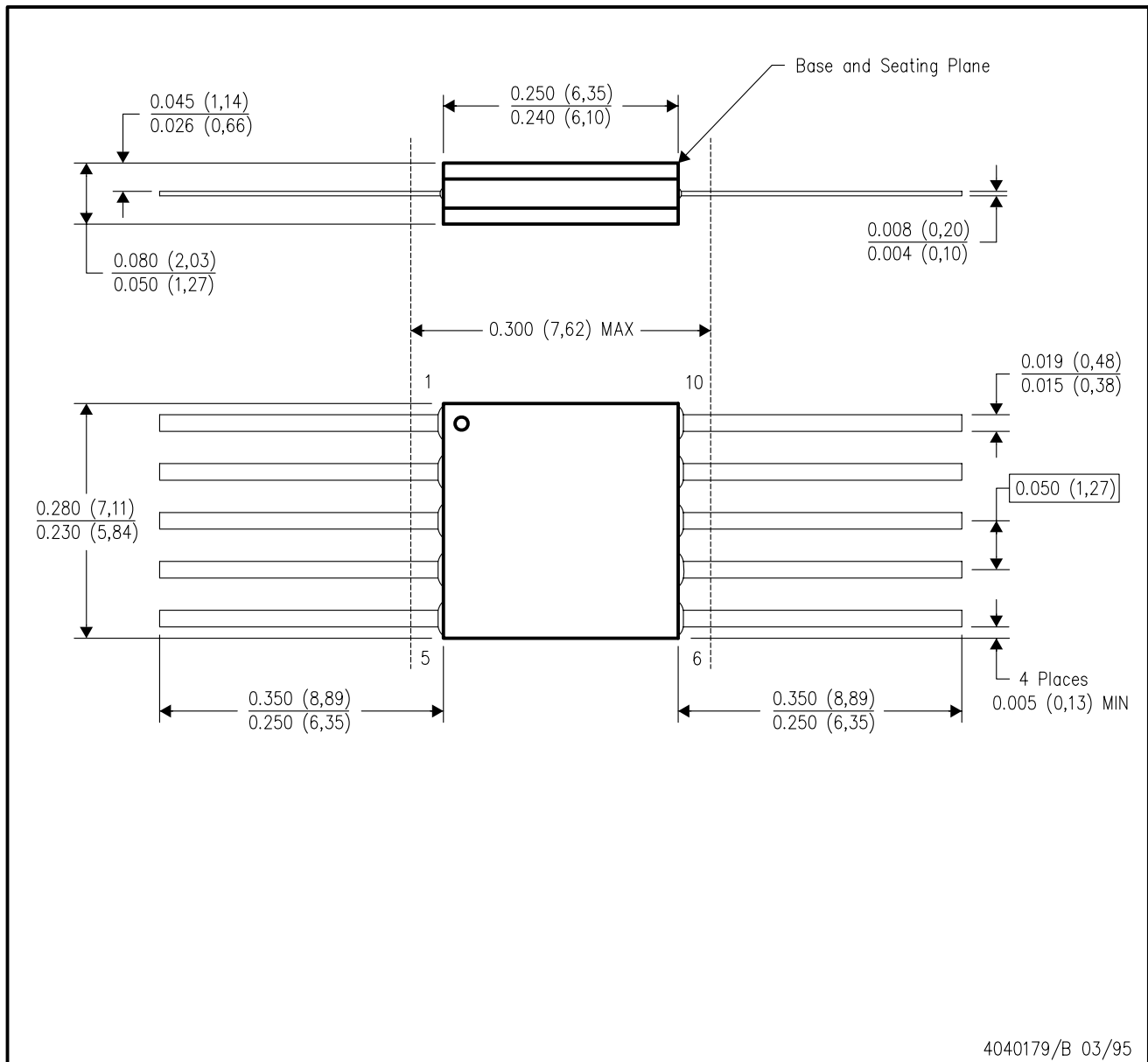

- NOTES:
- All linear dimensions are in inches (millimeters).
  - This drawing is subject to change without notice.
  - This package can be hermetically sealed with a ceramic lid using glass frit.
  - Index point is provided on cap for terminal identification only.
  - Falls within MIL STD 1835 GDFP1-F10 and JEDEC MO-092AA

## IMPORTANT NOTICE

Texas Instruments Incorporated and its subsidiaries (TI) reserve the right to make corrections, modifications, enhancements, improvements, and other changes to its products and services at any time and to discontinue any product or service without notice. Customers should obtain the latest relevant information before placing orders and should verify that such information is current and complete. All products are sold subject to TI's terms and conditions of sale supplied at the time of order acknowledgment.

TI warrants performance of its hardware products to the specifications applicable at the time of sale in accordance with TI's standard warranty. Testing and other quality control techniques are used to the extent TI deems necessary to support this warranty. Except where mandated by government requirements, testing of all parameters of each product is not necessarily performed.

TI assumes no liability for applications assistance or customer product design. Customers are responsible for their products and applications using TI components. To minimize the risks associated with customer products and applications, customers should provide adequate design and operating safeguards.

TI does not warrant or represent that any license, either express or implied, is granted under any TI patent right, copyright, mask work right, or other TI intellectual property right relating to any combination, machine, or process in which TI products or services are used. Information published by TI regarding third-party products or services does not constitute a license from TI to use such products or services or a warranty or endorsement thereof. Use of such information may require a license from a third party under the patents or other intellectual property of the third party, or a license from TI under the patents or other intellectual property of TI.

Reproduction of TI information in TI data books or data sheets is permissible only if reproduction is without alteration and is accompanied by all associated warranties, conditions, limitations, and notices. Reproduction of this information with alteration is an unfair and deceptive business practice. TI is not responsible or liable for such altered documentation. Information of third parties may be subject to additional restrictions.

Resale of TI products or services with statements different from or beyond the parameters stated by TI for that product or service voids all express and any implied warranties for the associated TI product or service and is an unfair and deceptive business practice. TI is not responsible or liable for any such statements.

TI products are not authorized for use in safety-critical applications (such as life support) where a failure of the TI product would reasonably be expected to cause severe personal injury or death, unless officers of the parties have executed an agreement specifically governing such use. Buyers represent that they have all necessary expertise in the safety and regulatory ramifications of their applications, and acknowledge and agree that they are solely responsible for all legal, regulatory and safety-related requirements concerning their products and any use of TI products in such safety-critical applications, notwithstanding any applications-related information or support that may be provided by TI. Further, Buyers must fully indemnify TI and its representatives against any damages arising out of the use of TI products in such safety-critical applications.

TI products are neither designed nor intended for use in military/aerospace applications or environments unless the TI products are specifically designated by TI as military-grade or "enhanced plastic." Only products designated by TI as military-grade meet military specifications. Buyers acknowledge and agree that any such use of TI products which TI has not designated as military-grade is solely at the Buyer's risk, and that they are solely responsible for compliance with all legal and regulatory requirements in connection with such use.

TI products are neither designed nor intended for use in automotive applications or environments unless the specific TI products are designated by TI as compliant with ISO/TS 16949 requirements. Buyers acknowledge and agree that, if they use any non-designated products in automotive applications, TI will not be responsible for any failure to meet such requirements.

Following are URLs where you can obtain information on other Texas Instruments products and application solutions:

### Products

Amplifiers	<a href="http://amplifier.ti.com">amplifier.ti.com</a>
Data Converters	<a href="http://dataconverter.ti.com">dataconverter.ti.com</a>
DSP	<a href="http://dsp.ti.com">dsp.ti.com</a>
Clocks and Timers	<a href="http://www.ti.com/clocks">www.ti.com/clocks</a>
Interface	<a href="http://interface.ti.com">interface.ti.com</a>
Logic	<a href="http://logic.ti.com">logic.ti.com</a>
Power Mgmt	<a href="http://power.ti.com">power.ti.com</a>
Microcontrollers	<a href="http://microcontroller.ti.com">microcontroller.ti.com</a>
RFID	<a href="http://www.ti-rfid.com">www.ti-rfid.com</a>
RF/IF and ZigBee® Solutions	<a href="http://www.ti.com/lprf">www.ti.com/lprf</a>

### Applications

Audio	<a href="http://www.ti.com/audio">www.ti.com/audio</a>
Automotive	<a href="http://www.ti.com/automotive">www.ti.com/automotive</a>
Broadband	<a href="http://www.ti.com/broadband">www.ti.com/broadband</a>
Digital Control	<a href="http://www.ti.com/digitalcontrol">www.ti.com/digitalcontrol</a>
Medical	<a href="http://www.ti.com/medical">www.ti.com/medical</a>
Military	<a href="http://www.ti.com/military">www.ti.com/military</a>
Optical Networking	<a href="http://www.ti.com/opticalnetwork">www.ti.com/opticalnetwork</a>
Security	<a href="http://www.ti.com/security">www.ti.com/security</a>
Telephony	<a href="http://www.ti.com/telephony">www.ti.com/telephony</a>
Video & Imaging	<a href="http://www.ti.com/video">www.ti.com/video</a>
Wireless	<a href="http://www.ti.com/wireless">www.ti.com/wireless</a>

Mailing Address: Texas Instruments, Post Office Box 655303, Dallas, Texas 75265  
Copyright © 2008, Texas Instruments Incorporated